

USING THE UNIT SAFELY

INSTRUCTIONS FOR THE PREVENTION OF FIRE, ELECTRIC SHOCK, OR INJURY TO PERSONS

About ⚠️ WARNING and ⚠️ CAUTION Notices

⚠️ WARNING	Used for instructions intended to alert the user to the risk of death or severe injury should the unit be used improperly.
⚠️ CAUTION	Used for instructions intended to alert the user to the risk of injury or material damage should the unit be used improperly. * Material damage refers to damage or other adverse effects caused with respect to the home and all its furnishings, as well to domestic animals or pets.

About the Symbols

	The ⚠️ symbol alerts the user to important instructions or warnings. The specific meaning of the symbol is determined by the design contained within the triangle. In the case of the symbol at left, it is used for general cautions, warnings, or alerts to danger.
	The ⚡ symbol alerts the user to items that must never be carried out (are forbidden). The specific thing that must not be done is indicated by the design contained within the circle. In the case of the symbol at left, it means that the unit must never be disassembled.
	The ⏻ symbol alerts the user to things that must be carried out. The specific thing that must be done is indicated by the design contained within the circle. In the case of the symbol at left, it means that the power-cord plug must be unplugged from the outlet.

ALWAYS OBSERVE THE FOLLOWING

⚠️ WARNING

- Before using this unit, make sure to read the instructions below, and the Owner's Manual.
- Do not open or perform any internal modifications on the unit.
- Do not attempt to repair the unit, or replace parts within it (except when this manual provides specific instructions directing you to do so). Refer all servicing to your retailer, the nearest Roland Service Center, or an authorized Roland distributor, as listed on the "Information" page.
- Never use or store the unit in places that are:
 - Subject to temperature extremes (e.g., direct sunlight in an enclosed vehicle, near a heating duct, on top of heat-generating equipment); or are
 - Damp (e.g., baths, washrooms, on wet floors); or are
 - Humid; or are
 - Exposed to rain; or are
 - Dusty; or are
 - Subject to high levels of vibration.
- Make sure you always have the unit placed so it is level and sure to remain stable. Never place it on stands that could wobble, or on inclined surfaces.

⚠️ WARNING

- This unit, either alone or in combination with an amplifier and headphones or speakers, may be capable of producing sound levels that could cause permanent hearing loss. Do not operate for a long period of time at a high volume level, or at a level that is uncomfortable. If you experience any hearing loss or ringing in the ears, you should immediately stop using the unit, and consult an audiologist.
- Do not allow any objects (e.g., flammable material, coins, pins); or liquids of any kind (water, soft drinks, etc.) to penetrate the unit.
- Immediately turn the power off, and request servicing by your retailer, the nearest Roland Service Center, or an authorized Roland distributor, as listed on the "Information" page when:
 - If smoke or unusual odor occurs
 - Objects have fallen into, or liquid has been spilled onto the unit; or
 - The unit has been exposed to rain (or otherwise has become wet); or
 - The unit does not appear to operate normally or exhibits a marked change in performance.

⚠ WARNING

- In households with small children, an adult should provide supervision until the child is capable of following all the rules essential for the safe operation of the unit. 

- Protect the unit from strong impact. (Do not drop it!) 

- DO NOT play a CD-ROM disc on a conventional audio CD player. The resulting sound may be of a level that could cause permanent hearing loss. Damage to speakers or other system components may result. 

⚠ CAUTION

- Try to prevent cords and cables from becoming entangled. Also, all cords and cables should be placed so they are out of the reach of children. 

- Never climb on top of, nor place heavy objects on the unit. 

- Disconnect all cords coming from external devices before moving the unit. 

IMPORTANT NOTES

In addition to the items listed under “USING THE UNIT SAFELY” on page 2 -3, please read and observe the following:

Power Supply

- Before connecting this unit to other devices, turn off the power to all units. This will help prevent malfunctions and/or damage to speakers or other devices.

Placement

- This device may interfere with radio and television reception. Do not use this device in the vicinity of such receivers.
- Noise may be produced if wireless communications devices, such as cell phones, are operated in the vicinity of this unit. Such noise could occur when receiving or initiating a call, or while conversing. Should you experience such problems, you should relocate such wireless devices so they are at a greater distance from this unit, or switch them off.
- Do not expose the unit to direct sunlight, place it near devices that radiate heat, leave it inside an enclosed vehicle, or otherwise subject it to temperature extremes. Excessive heat can deform or discolor the unit.
- When moved from one location to another where the temperature and/or humidity is very different, water droplets (condensation) may form inside the unit. Damage or malfunction may result if you attempt to use the unit in this condition. Therefore, before using the unit, you must allow it to stand for several hours, until the condensation has completely evaporated.
- Do not allow objects to remain on top of the keyboard. This can be the cause of malfunction, such as keys ceasing to produce sound.

Maintenance

- For everyday cleaning wipe the unit with a soft, dry cloth or one that has been slightly dampened with water. To remove stubborn dirt, use a cloth impregnated with a mild, non-abrasive detergent. Afterwards, be sure to wipe the unit thoroughly with a soft, dry cloth.
- Never use benzine, thinners, alcohol or solvents of any kind, to avoid the possibility of discoloration and/or deformation.

Repairs and Data

- Please be aware that all data contained in the unit’s memory may be lost when the unit is sent for repairs. Important data should always be backed up in another MIDI device (e.g., a sequencer), or written down on paper (when possible). During repairs, due care is taken to avoid the loss of data. However, in certain cases (such as when circuitry related to memory itself is out of order), we regret that it may not be possible to restore the data, and Roland assumes no liability concerning such loss of data.

Additional Precautions

- Please be aware that the contents of memory can be irretrievably lost as a result of a malfunction, or the improper operation of the unit. To protect yourself against the risk of losing important data, we recommend that you periodically save a backup copy of important data you have stored in the unit’s memory in another MIDI device (e.g., a sequencer).
- Unfortunately, it may be impossible to restore the contents of data that was stored in the unit’s memory once it has been lost. Roland Corporation assumes no liability concerning such loss of data.
- Use a reasonable amount of care when using the unit’s buttons, sliders, or other controls; and when using its jacks and connectors. Rough handling can lead to malfunctions.
- When connecting / disconnecting all cables, grasp the connector itself—never pull on the cable. This way you will avoid causing shorts, or damage to the cable’s internal elements.
- To avoid disturbing your neighbors, try to keep the unit’s volume at reasonable levels. You may prefer to use headphones, so you do not need to be concerned about those around you (especially when it is late at night).
- When you need to transport the unit, package it in the box (including padding) that it came in, if possible. Otherwise, you will need to use equivalent packaging materials.

- Use a cable from Roland to make the connection. If using some other make of connection cable, please note the following precautions.
 - Some connection cables contain resistors. Do not use cables that incorporate resistors for connecting to this unit. The use of such cables can cause the sound level to be extremely low, or impossible to hear. For information on cable specifications, contact the manufacturer of the cable.

Handling CD-ROMs

- Avoid touching or scratching the shiny underside (encoded surface) of the disc. Damaged or dirty CD-ROM discs may not be read properly. Keep your discs clean using a commercially available CD cleaner.

Copyright

- Unauthorized recording, distribution, sale, lending, public performance, broadcasting, or the like, in whole or in part, of a work (musical composition, video, broadcast, public performance, or the like) whose copyright is held by a third party is prohibited by law.
 - When exchanging audio signals through a digital connection with an external instrument, this unit can perform recording without being subjected to some of the restrictions of the Serial Copy Management System (SCMS). This is because the unit is intended solely for musical production, and is designed not to be subject to restrictions as long as it is used to record works (such as your own compositions) that do not infringe on the copyrights of others. (SCMS is a feature that prohibits second-generation and later copying through a digital connection. It is built into MD recorders and other consumer digital-audio equipment as a copyright-protection feature.)
 - Do not use this unit for purposes that could infringe on a copyright held by a third party. We assume no responsibility whatsoever with regard to any infringements of third-party copyrights arising through your use of this unit.
- * Windows® is known officially as: "Microsoft® Windows® operating system."*Microsoft and Windows are registered trademarks of Microsoft Corporation.
 - * The screen shots in this document are used in compliance with the guidelines of the Microsoft Corporation.
 - * Apple and Macintosh are registered trademark of Apple Computer, Inc.
 - * MacOS is a trademark of Apple Computer, Inc.
 - * OMS is a registered trademark of Opcode Systems, Inc.
 - * FreeMIDI is a trademark of Mark of the Unicorn, Inc.



To install the software, first run the software from the CD-ROM. If you have not yet purchased the PC software, please contact your local distributor for more information.

Controller Panel



Your controller panel is located in the front of the unit. The controller panel is used to adjust the volume and tone of the speaker.

For more information on the controller panel, see the manual that is included in the package.

For use with the controller panel, see the manual that is included in the package.

Speaker

The speaker is a 2-way speaker that is assigned to the left channel. The speaker is also included in the package.

See

Quick page reference table

Before you begin	Driver Installation	p. 14, p. 31	
	Settings	p. 44	
	Names of things and what they do	p. 9	
	Table of operating modes	p. 50	
	System settings	p. 93	
Using the audio functionality	Audio and MIDI flow	p. 43	
	Playing sounds on your computer	p. 46	
	Recording sound on your computer	p. 47	
	Digital recording the output of the PCR-1 on a CD/MD/DAT	p. 49	
Using the MIDI functionality	Startup mode	p. 51	
	Features Useful When Playing	p. 52	
	Pitch Bend	p. 52	
	Modulation	p. 52	
	Octave Shift	p. 52	
	Transpose	p. 52	
	Changing memory sets	p. 59	
	Transmitting the current controller values all at once	p. 60	
	Assign MIDI messages	p. 61	
	Note Assign	p. 63	
	Aftertouch Assign	p. 65	
	Control Change Assign	p. 68	
	Program Change Assign	p. 71	
	RPN/NRPN Assign	p. 74	
	Sys Ex. Assign	p. 77	
	Tempo Assign	p. 85	
	Copying a MIDI message assignment	p. 86	
	Canceling a MIDI message assignment	p. 87	
	Saving a memory set	p. 88	
	Transmitting/receiving bulk data	p. 89	
	Protecting a memory set	p. 92	
	Making system settings	F8 Clock	p. 94
Velocity Offset		p. 94	
Keyboard Port Set		p. 94	
H-Activity On / Off		p. 95	
USB MIDI Driver Mode		p. 95	
Startup Memory		p. 95	
Factory Reset		p. 95	
Pitch Bend Time		p. 97	
USB Audio Sampling Frequency		p. 96	
USB Audio Driver Mode		p. 96	
Direct Monitor On / Off		p. 97	
Pitch Bend Time		p. 97	
Modulation Setting		p. 97	
Trouble Shooting		Problems related to the USB driver	p. 106
		Problems when using the PCR-1	p. 111

Contents

USING THE UNIT SAFELY	3
IMPORTANT NOTES	4
Contents of the package	6
Quick page reference table	7
Names of things and what they do	9
Panel	9
Rear Panel	12

Setup 13

Getting Connected and Installing Drivers (Windows)	14
Installing the driver	14
Settings and checking	26
Getting Connected and Installing Drivers (Macintosh)	31
Mac OS X users	31
Installing the driver	31
Setting the audio device.....	32
Mac OS 9 users.....	33
Installing the PCR-1 driver.....	33
Setting the driver	34
Installing the ASIO driver	38

Operation 41

Basic use	42
Basic connections.....	42
Audio and MIDI flow	43
Input / output devices	44
Use audio functionality	46
Playing sounds on your computer.....	46
Recording sound on your computer	47
Digitally recording sound from your computer.....	49
Use MIDI functionality	50
Table of operating modes.....	50
Startup mode.....	51
Features Useful When Playing	52
Setting the MIDI Transmit Channel	53

Selecting Sounds on a Sound Module (Sending Program Change / Bank Select Messages).....	55
Transmitting a Reset message.....	58
Changing the Memory Sets	59
Transmitting the current controller values all at once (SNAPSHOT).....	60
Assign MIDI messages (EDIT).....	61
NOTE ASSIGN	63
AFTERTOUCH ASSIGN.....	65
CONTROL CHANGE ASSIGN	68
PROGRAM CHANGE ASSIGN.....	71
RPN / NRPN ASSIGN	74
Sys Ex. ASSIGN	77
TEMPO ASSIGN	85
Copying a MIDI message assignment (ASSIGN COPY)	86
Canceling a MIDI message assignment (NO ASSIGN)	87
Saving a memory set (SAVE)	88
Transmitting/receiving bulk data (BULK).....	89
Protecting a memory set (PROTECT).....	92

System settings 93

Appendices 99

Memory sets	100
Troubleshooting	106
Problems related to the USB driver.....	106
Problems when using the PCR-1	111
MIDI implementation	117
Main specifications	122
index	123

Names of things and what they do

Panel

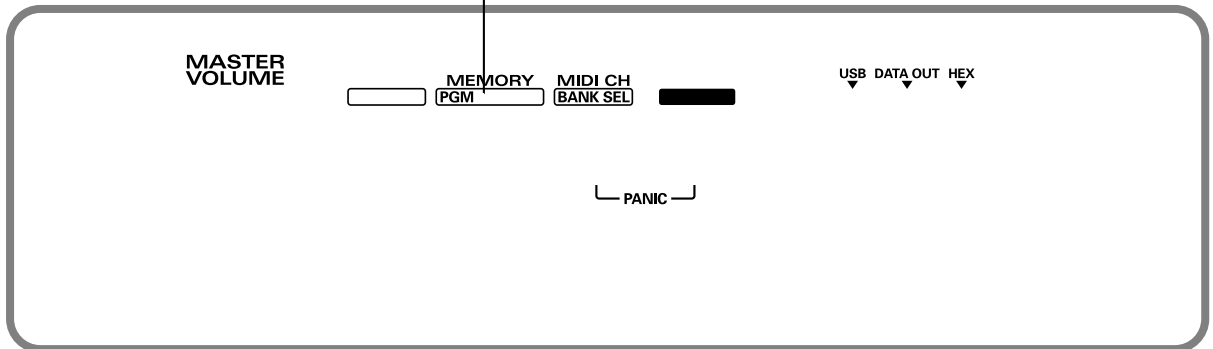

1 Master volume knob

This adjusts the volume that is output from the headphone jack, the master output jacks.

* This does not effect the volume that is output from the digital output jacks.

2 SHIFT Button

Use this in conjunction with other buttons.

3 MEMORY / PGM CHANGE Button

Press the [MEMORY] Button	Accesses memories that are stored within the PCR-1.
Press the [SHIFT] so it is lit, and then press the [MEMORY].	Transmits program change messages on the current channel.

4 MIDI CH / BANK SEL Button

Press the [MIDI CH] Button	Specifies the transmission channel (“current channel”) for the keyboard and bender.
Press the [SHIFT] so it is lit, and then press the [MIDI CH].	Transmits bank select messages on the current channel.

5 EDIT Button

Used to assign MIDI messages to the controllers.

6 Display

Indicates the current status and various other information.

USB	Lights if the PCR-1 is connected to your computer via USB.
DATA OUT	This will blink when MIDI messages are transmitted via USB or MIDI OUT.
HEX	Lights when the value shown in the display is hexadecimal.

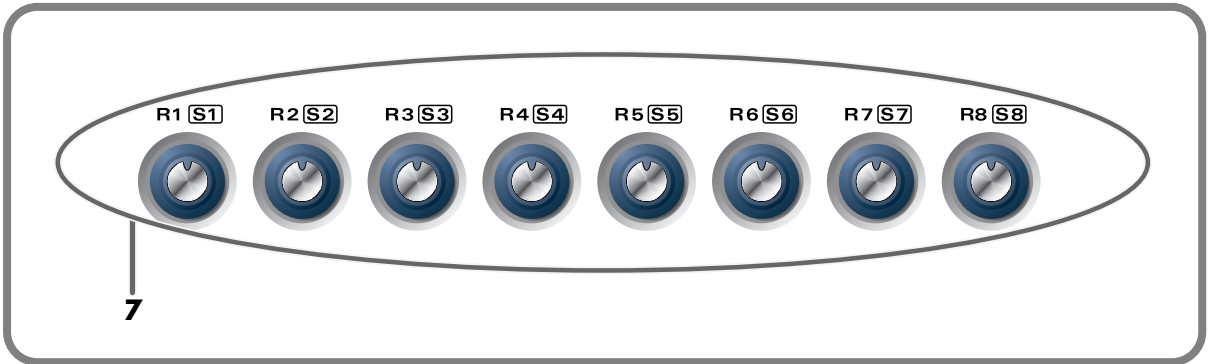

7 Controllers [R1] – [R8] , [S1] ([SHIFT] + [R1]) – [S8] ([SHIFT] + [R8])

You can assign MIDI messages to these controllers.

(→Assign MIDI messages (EDIT) (p. 61))

When the [SHIFT] button is unlit (SHIFT OFF), these controllers correspond to [R1]–[R8]. When the button is lit (SHIFT ON), they correspond to [S1]–[S8].

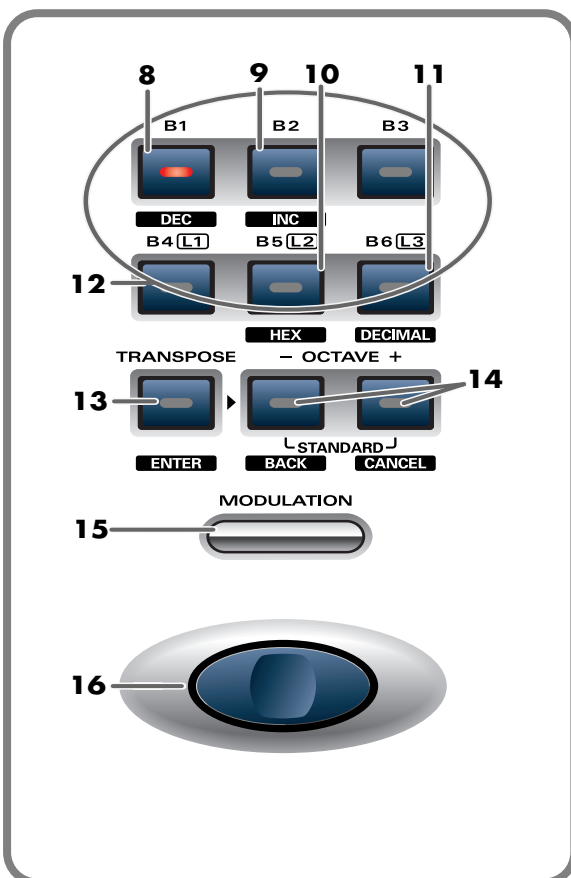

8 DEC Button

Decreases the value of a setting by one (except in **PLAY mode** (p. 51)).

9 INC Button

Increases the value of a setting by one (except in **PLAY mode** (p. 51)).

10 HEX Button

When not in **PLAY mode** (p. 51), sets the input mode to Hexadecimal (Hexadecimal input mode).

11 DECIMAL Button

When not in **PLAY mode** (p. 51), sets the input mode to Decimal (Decimal input mode).

12 Controllers [B1] – [B6], [L1] – [L3]

You can assign MIDI messages to these controllers. (→Assign MIDI messages (EDIT) (p. 61))

13 TRANSPOSE / ENTER Button

Use **[TRANSPOSE]** + **[OCTAVE -/+]** to transpose the pitch of the keyboard in semitone steps. Also, in any mode except PLAY mode, it functions as the **[ENTER]** button, which you need to press to confirm the settings you've made.

14 OCTAVE - / +

Press **[OCTAVE - / +]** to shift the pitch of the keyboard up or down in steps of an octave. When not in PLAY mode, use these buttons to return to the previous setting item (the **[BACK]** button) or to cancel the setting and return to PLAY mode (the **[CANCEL]** button).

15 MODULATION Button

This button can be used to apply vibrato.

16 BENDER Switch

This switch can be used to modify the pitch.

Rear Panel

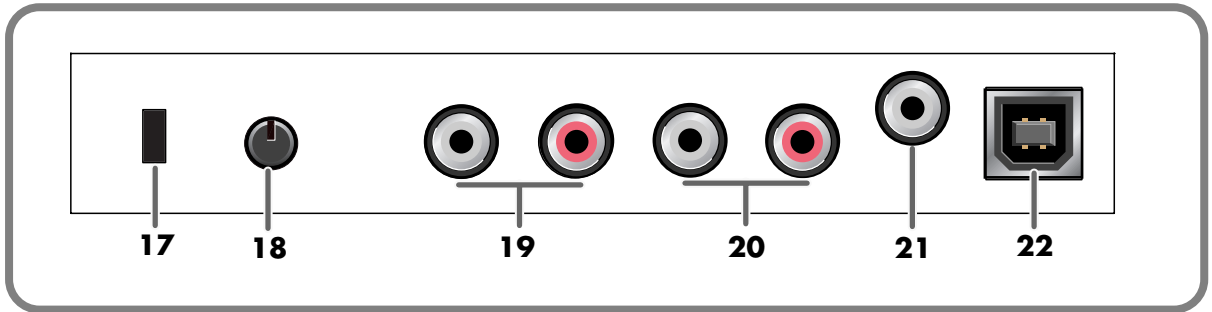

17 Security Slot ()

<http://www.kensington.com/>

18 Input volume

This dual concentric knob adjusts the input level to **input jacks L and R**.

19 Input jacks (PCA Pin Type)

These are input jacks for analog audio signals. You can connect dynamic mics, guitars, or audio devices. You must set the **Input select switch** to the position appropriate for the device you have connected.

If you connect a guitar or mic only to the L jack or R jack, the signal will be monaural.

20 Master output jacks (PCA Pin Type)

These are analog audio output jacks. You can connect them to your external monitor speaker system.

21 Digital output jack / Headphone jack

* *The same jack serves as both the headphone jack and digital output jack.*



Optical

These are digital jacks for connecting optical cables. Digital jacks for connecting coaxial cables are labeled Coaxial.

- Use these jacks to output digital audio to a digital audio device such as a MD/DAT. On the PCR-1, the input from the input jacks cannot be output directly to the Digital output connector.
- You can connect a set of headphones to this jack. The headphone jack will output the same signal as the master output jacks and digital output jacks. Sound will be output from the master output jacks even if headphones are connected.

22 USB connector

Use this when connecting the PCR-1 to your computer via a USB cable.

Setup

This section explains how to install the drivers needed for connecting the PCR-1 to a computer, and make the necessary settings.

Getting Connected and Installing Drivers (Windows)..... (p. 14)

Getting Connected and Installing Drivers (Macintosh)..... (p. 31)

What is a driver?

A “**driver**” is software that transfers data between the PCR-1 and application software running on your computer, when your computer and the PCR-1 are connected by a USB cable. The driver sends data from your application to the PCR-1, and from the PCR-1 to your application.

Getting Connected and Installing Drivers (Windows)

Installing the driver

The installation procedure will differ depending on your system. Please proceed to one of the following sections, depending on the system you use.

- Windows XP users (p. 14)
- Windows 2000 users..... (p. 20)
- Windows Me/98 users (p. 25)

Windows XP users

1 Disconnect all USB cables except for a USB keyboard and USB mouse (if used).

2 Open the **System Properties** dialog box.

1. Click the Windows **start** menu, and from the menu, select Control Panel.
2. In “Pick a category”, click “Performance and Maintenance”.
3. In “or pick a Control Panel icon”, click the **System** icon.

3 Click the **Hardware** tab, and then click [**Driver Signing**].
Open the **Driver Signing Options** dialog box.

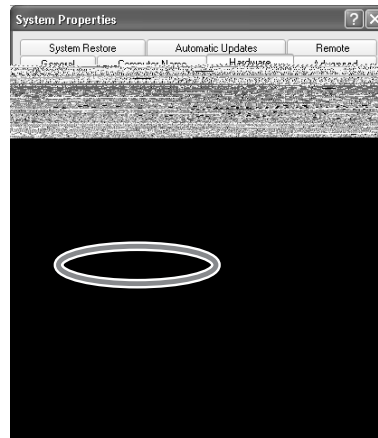

4 Make sure that “What action do you want Windows to take?” is set to “Ignore”.

If it is set to “Ignore”, simply click [**OK**].

If it is not set to “Ignore”, make a note of the current setting (“Warn” or “Block”). Then change the setting to “Ignore” and click [**OK**].

NOTE

If you are using Windows XP Professional, you must log on using a user name with an administrative account type (e.g., Administrator). For details on user accounts, please consult the system administrator of your computer.

MEMO

Depending on how your system is set up, the **System** icon may be displayed directly in the **Control Panel** (the Classic view). In this case, double-click the **System** icon.

MEMO

If you changed “What action do you want Windows to take?”, you must restore the previous setting after you have installed the driver. (If you changed “What action do you want Windows to take?” (p. 18))

5 Click **[OK]** to close the **System Properties** dialog box.

6 Exit all currently running software (applications).
Also close any open windows. If you are using virus checking or similar software, be sure to exit it as well.

7 Prepare the CD-ROM.
Insert the CD-ROM into the CD-ROM drive of your computer.

8 Click the Windows **start** button. From the menu that appears, select **“Run...”**
The **“Run...”** dialog box will appear.

9 Specify the name of the file you want to execute.
Enter the following into the **“Open”** field, and click **[OK]**.



(drive name) : \Driver\USB_XP2K\SETUPINF.EXE

The **SetupInf** dialog box will appear.
You are now ready to install the driver.

** In the explanatory example shown here, the drive name is given as **“D:”**. The drive name **“D:”** may be different for your system. Specify the drive name of your CD-ROM drive.*

10 Use the **USB cable** to connect the **PCR-1** to your **computer**.

Near the task bar, your computer will indicate **“Found New Hardware”**.
Please wait.

11 The **Found New Hardware Wizard** will appear.

Select **“Install from a list or specific location (Advanced)”**, and click **[Next]**.

MEMO

If the screen indicates **“Windows can perform the same action each time you insert a disk or connect a device with this kind of file”**, click **[Cancel]**.

MEMO

To check the drive name

Click the **Start** button, and choose **My Computer** from the menu that appears. In the window that appears, check the drive name of the CD-ROM drive into which you inserted the CD-ROM in step 7. The drive name is the (D:) or (E:) displayed by the CD-ROM drive .

MEMO

This unit is equipped with a protection circuit. A brief interval (a few seconds) after connecting the USB cable is required before the unit will operate normally.

12

The screen will indicate **“Please choose your search and installation options”**.

Select **“Don’t search. I will choose the driver to install”**, and click **[Next]**.

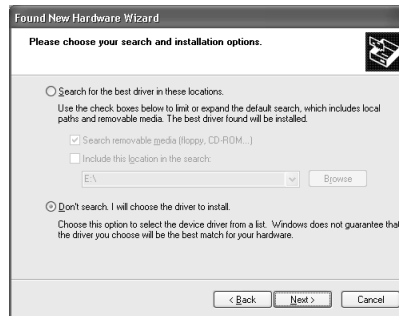
**13**

Make sure that the **“Model”** field indicates **“EDIROL PCR-1 WAVE”** or **“EDIROL PCR-1 MIDI”**, and click **[Next]**. Driver installation will begin.

If the **“What action do you want Windows to take?”** (Step 4) setting was not set to **“Ignore”**, a **“Hardware Installation”** dialog box will appear.

If “What action do you want Windows to take?” is set to “Warn”

A dialog box with a **“!”** symbol will appear.

1. Click **[Continue Anyway]**.
2. Continue the installation.

If “What action do you want Windows to take?” is set to “Block”

A dialog box with a **“x”** symbol will appear.

1. Click **[OK]**.
2. When the **“Found New Hardware Wizard”** appears, click **[Finish]**.
3. Return to **step 1** (p. 14) and re-install the driver from the beginning of the procedure.

14

The **Insert Disk** dialog box will appear.

Click **[OK]**.

15

The **Files Needed** dialog box will appear.

Input the following into the **“Copy files from”** field, and click **[OK]**.

(drive name):\DRIVER\USB_XP2K

MEMO

The **Insert Disk** dialog may not appear. In that case, proceed to the next step.

MEMO

Specify the drive name of your CD-ROM drive..

If the **“What action do you want Windows to take?”** (Step 4) setting was not set to **“Ignore”**, a **“Hardware Installation”** dialog box will appear.

If “What action do you want Windows to take?” is set to “Warn”

A dialog box with a **“!”** symbol will appear.

1. Click **[Continue Anyway]**.
2. Continue the installation.

16

The screen will indicate “**Completing the Found New Hardware Wizard**”.

Click [**Finish**].

17

The **Found New Hardware Wizard** will appear again.

select “**Install from a list or specific location (Advanced)**”, and click [**Next**].

18

The screen will indicate “**Please choose your search and installation options**”.

Select “**Don’t search. I will choose the driver to install**”, and click [**Next**].

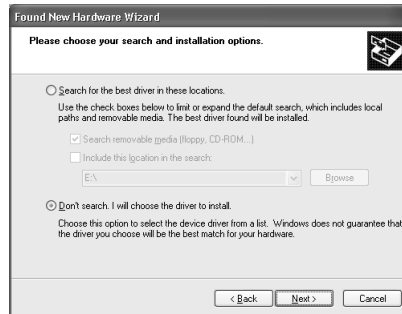
**19**

Make sure that the “**Model**” field indicates “**EDIROL PCR-1 WAVE**” or “**EDIROL PCR-1 MIDI**”, and click [**Next**]. Driver installation will begin.

If the “**What action do you want Windows to take?**” (Step 4) setting was not set to “**Ignore**”, a “**Hardware Installation**” dialog box will appear.

If “**What action do you want Windows to take?**” is set to “**Warn**”

A dialog box with a “!” symbol will appear.

1. Click [**Continue Anyway**].
2. Continue the installation.

20

The **Insert Disk** dialog box will appear.

Click [**OK**].

MEMO

The **Insert Disk** dialog may not appear. In that case, proceed to the next step.

21

The **Files Needed** dialog box will appear.

Input the following into the “**Copy files from**” field, and click [**OK**].
(drive name):\DRIVER\USB_XP2K

MEMO

Specify the drive name of your CD-ROM drive.

If the “**What action do you want Windows to take?**” (Step 4) setting was not set to “**Ignore**”, a “**Hardware Installation**” dialog box will appear.

If “What action do you want Windows to take?” is set to “Warn”

A dialog box with a “!” symbol will appear.

1. Click [**Continue Anyway**].
2. Continue the installation.

22

The screen will indicate “**Completing the Found New Hardware Wizard**”.

Click [**Finish**].

Wait until “**Found New Hardware**” appears near the taskbar.

23

When driver installation has been completed, the **System Settings Change** dialog box will appear.

Click [**Yes**]. Windows will restart automatically.

MEMO

If the **System Settings Change** dialog box does not appear, restart Windows from the Start menu.

If you changed “What action do you want Windows to take?”

If you changed the **What action do you want Windows to take?** (p. 14) setting, restore the original setting after Windows restarts.

1. Log on to Windows using the user name of an administrative account (e.g., Administrator).
2. Click the Windows **start** button, and from the menu that appears, select **Control Panel**.
3. In “**Pick a category**,” click “**Performance and Maintenance**”.
4. In “**or pick a Control Panel icon**”, click the **System** icon. The **System Properties** dialog box will appear.
5. Click the **Hardware** tab, and then click [**Driver Signing**]. The **Driver Signing Options** dialog box will appear.
6. Return the **What action do you want Windows to take?** setting to the original setting (either “Warn” or “Block”), and click [**OK**].
7. Click [**OK**]. The **System properties** dialog box will close.

MEMO

Depending on how your system is set up, the **System** icon may be displayed directly in the Control Panel (classic view). In this case, double-click the **System** icon.

This completes installation of the driver.

Next, we recommend that you **enable background processing** on your computer, so MIDI and audio processing will be as smooth as possible.(→ **Enabling background processing** (p. 19))

■ Enabling background processing

In Windows XP, make settings to enable background processing. If you fail to make this setting, you may experience interruptions in the sound. To ensure that MIDI and audio processing occurs smoothly, use the following procedure to make settings.

- 1** ▶ Open the **System Properties** dialog box.
 - 1.** Click the Windows start menu, and from the menu, select Control Panel.
 - 2.** In “Pick a category”, click “Performance and Maintenance”.
 - 3.** In “or pick a Control Panel icon”, click the **System** icon.
- 2** ▶ Click the **Advanced** tab.
- 3** ▶ At the right of the **Performance** field, click **[Settings]**.
The **Performance Options** dialog box will appear.
- 4** ▶ Click the **Advanced** tab.

- 5** ▶ In the **Processor Scheduling** field, select “**Background services**”, and click **[OK]**.

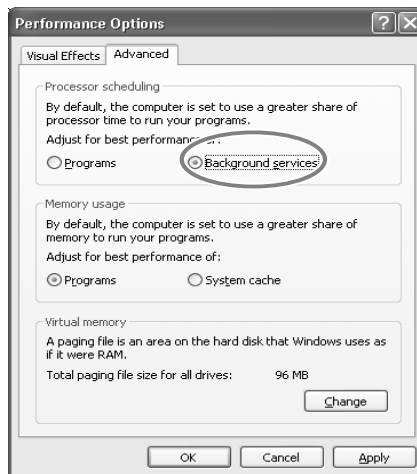

- 6** ▶ In the **System Properties** dialog box, click **[OK]**.
The **System Properties** dialog box will close.

Next, make MIDI device and audio device settings.

(→ **Specifying the audio and MIDI input/output destination** (p. 26))

MEMO

Depending on how your system is set up, the **System** icon may be displayed directly in the **Control Panel** (the Classic view). In this case, double-click the **System** icon.

Windows 2000 users

1

Disconnect all USB cables except for a USB keyboard and USB mouse (if used).

2

Open the **System Properties** dialog box.

Click the Windows **Start** button, and from the menu that appears, select **Settings | Control Panel**. In **Control Panel**, double-click the **System** icon.

3

Click the **Hardware** tab, and then click **[Driver Signing]**.

The **Driver Signing Options** dialog box will appear.

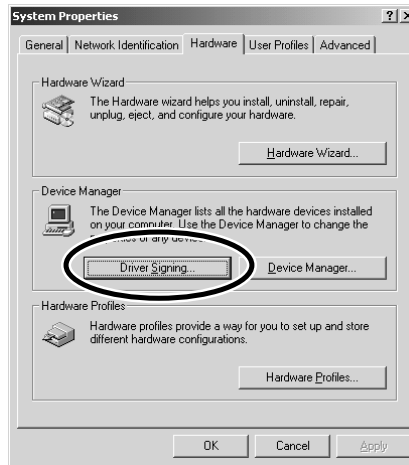

4

Make sure that “**File signature verification**” is set to “**Ignore**”.

If it is set to “**Ignore**”, simply click **[OK]**.

If it is not set to “**Ignore**”, make a note of the current setting (“**Warn**” or “**Block**”). Then change the setting to “**Ignore**” and click **[OK]**.

5

Click **[OK]** to close the **System Properties** dialog box.

6

Exit all currently running software (applications).

Also close any open windows. If you are using virus checking or similar software, be sure to exit it as well.

7

Prepare the CD-ROM.

Insert the CD-ROM into the CD-ROM drive of your computer.

8

Click the Windows **Start** button. From the menu that appears, select “**Run...**”

The “**Run...**” dialog box will appear.

MEMO

Log on to Windows as a user with administrative privileges (such as Administrator)

MEMO

If you changed “**File signature verification**”, you must restore the previous setting after you have installed the driver. (→If you changed “**File signature verification**” (p. 23))

9

In the dialog box that appears, input the following into the “Open” field, and click [OK].

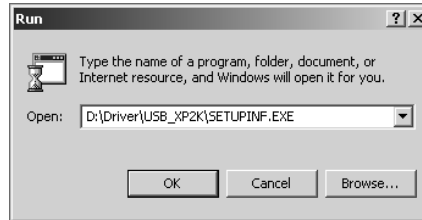

(drive name) : \Driver\USB_XP2K\SETUPINF.EXE

The **SetupInf** dialog box will appear.
You are now ready to install the driver.

* In the explanatory example shown here, the drive name is given as “D:”. The drive name “D:” may be different for your system. Specify the drive name of your CD-ROM drive.

10

Use the **USB cable** to connect the **PCR-1** to your **computer**.

If the “**File signature verification**” (Step 4) setting was not set to “**Ignore**”, a “**Digital Signature Not Found**” dialog box will appear.

If “**File signature verification**” is set to “**Warn**”

1. Click [Yes].
2. Continue the installation.

If “**File signature verification**” is set to “**Block**”

1. Click [OK].
2. When the “**Found New Hardware Wizard**” appears, click [Finish].
3. Return to **step 1** (p. 20) and re-install the driver from the beginning of the procedure.

11

The **Insert Disk** dialog box will appear.
Click [OK].

12

The **Files Needed** dialog box will appear.

Input the following into the “**Copy files from**” field, and click [OK].
(drive name) : \DRIVER\USB_XP2K

MEMO

To check the drive name

In the Windows desktop, double-click the **My Computer** icon. In the window that appears, check the drive name of the CD-ROM drive into which you inserted the CD-ROM in step 7. The drive name is the (D:) or (E:) displayed by the CD-ROM drive.

MEMO

This unit is equipped with a protection circuit. A brief interval (a few seconds) after connecting the USB cable is required before the unit will operate normally.

MEMO

If the **Insert Disk** dialog box does not appear, proceed to the next step.

MEMO

Specify the drive name of your CD-ROM drive.

If the “**File signature verification**” (Step 4) setting was not set to “**Ignore**,” a “**Digital Signature Not Found**” dialog box will appear.

If “File signature verification” is set to “Warn”

1. Click [**Yes**].
2. Continue the installation.

13

The screen will indicate “**Completing the Found New Hardware Wizard**”.

Click [**Finish**].

14

The **System Settings Change** dialog box will appear.

Click [**Yes**]. Windows will restart automatically.

Log on to Windows as a user with administrative privileges (e.g., Administrator).

15

After you have logged on to Windows, the **Insert Disk** dialog box will appear again. Click [**OK**].



If the **Insert Disk** dialog box does not appear, proceed to the next step.

16

The **Files Needed** dialog box will appear.

Input the following into the “**Copy files from**” field, and click [**OK**].
(drive name) : \DRIVER\USB_XP2K



Specify the drive name of your CD-ROM drive.

If the “**File signature verification**” (Step 4) setting was not set to “**Ignore**,” a “**Digital Signature Not Found**” dialog box will appear.

If “File signature verification” is set to “Warn”

1. Click [**Yes**].
2. Continue the installation.

17

The screen will indicate “**Completing the Found New Hardware Wizard**”.

Click [**Finish**].



If the **Found New Hardware Wizard** dialog box does not appear, proceed to the next step.

18

The **System Settings Change** dialog box may appear.

Click **[Yes]**. Windows will restart automatically.

If the **System Settings Change** dialog box does not appear, restart Windows from the Start menu.

MEMO

If the **System Settings Change** dialog box does not appear, restart Windows from the Start menu.

If you changed “File signature verification”

If you changed the “**File signature verification**” (p. 20) setting, restore the original setting after Windows restarts.

1. After Windows restarts, log in to Windows as a user with **administrative privileges**, (such as **Administrator**).
2. In the Windows desktop, right-click the **My Computer** icon, and from the menu that appears, select **Properties**. The **System Properties** dialog box will appear.
3. Click the **Hardware** tab, and then click **[Driver Signing]**. The **Driver Signing Options** dialog box will appear.
4. Return the “**File signature verification**” setting to the original setting (either “Warn” or “Block”), and click **[OK]**.
5. Click **[OK]**. The **System Properties** dialog box will close.

This completes installation of the driver.

Next, we recommend that you enable background processing on your computer, so MIDI and audio processing will be as smooth as possible. (→ **Enabling background processing** (p. 24))

■ Enabling background processing

In Windows 2000, make settings to enable background processing. If you fail to make this setting, you may experience interruptions in the sound. To ensure that MIDI and audio processing occurs smoothly, use the following procedure to make settings.

1 Click the Windows **Start** button, and from the menu that appears, select **Settings | Control Panel**. In **Control Panel**, double-click the **System** icon.

2 Click the **Advanced** tab.

3 At the right of the **Performance** field, click [**Performance Options**].
The **Performance Options** dialog box will appear.

4 In the **Application response** field, choose “**Background services**” and click [**OK**].

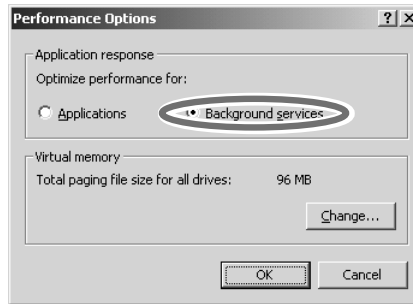

5 Click [**OK**] to close the **System Properties** dialog box.

Next, make MIDI device and audio device settings.
(→**Specifying the audio and MIDI input/output destination** (p. 26))

Windows Me/98 users

1

With the PCR-1 disconnected, start up Windows.

Disconnect all USB cables except for a USB keyboard and USB mouse (if used).

If you are using virus checking or similar software, be sure to exit it as well.

2

Exit all currently running software (applications).

Also close any open windows. If you are using virus checking or similar software, be sure to exit it as well.

3

Prepare the CD-ROM.

Insert the CD-ROM into the CD-ROM drive of your computer.

4

Click the Windows **Start** button. From the menu that appears, select **Run...**

The “Run...” dialog box will appear.

5

In the dialog box that appears, input the following into the “Open” field, and click [OK].

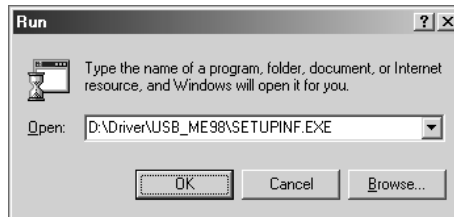

(drive name) : \Driver\USB_ME98\SETUPINF.EXE

The **SetupInf** dialog box will appear.

You are now ready to install the driver.

* In the explanatory example shown here, the drive name is given as “D:”. The drive name “D:” may be different for your system. Specify the drive name of your CD-ROM drive.

6

Use the **USB cable** to connect the **PCR-1** to your **computer**.

The driver will be installed automatically.

7

In the SetupInf dialog box, click [OK].

Next, make MIDI device and audio device settings.

(→**Specifying the audio and MIDI input/output destination** (p. 26))

MEMO

To check the drive name

In the Windows desktop, double-click the **My Computer** icon. In the window that appears, check the drive name of the CD-ROM drive into which you inserted the CD-ROM in step 3.

The drive name is the (D:) or (E:) displayed by the CD-ROM drive .

MEMO

This unit is equipped with a protection circuit. A brief interval (a few seconds) after connecting the USB cable is required before the unit will operate normally.

MEMO

If a message recommends that you restart Windows, restart Windows as directed.

Settings and checking

■ Specifying the audio and MIDI input/output destination

Windows XP users

1

Open **Control Panel**.

Click the Windows **start** button, and from the menu that appears, select **Control Panel**.

2

Open the **Sounds and Audio Devices Properties** dialog box.

In “**Pick a category**” click “**Sound, Speech, and Audio Devices**”. Next, in “**or pick a Control Panel icon**”, click the **sounds and Audio Devices** icon.

3

Click the **Audio** tab.

4

For **MIDI music playback**, click the located at the right of **[Default device]**, and select the following from the list that appears.

Sound playback	EDIROL PCR-1
Sound recording	EDIROL PCR-1

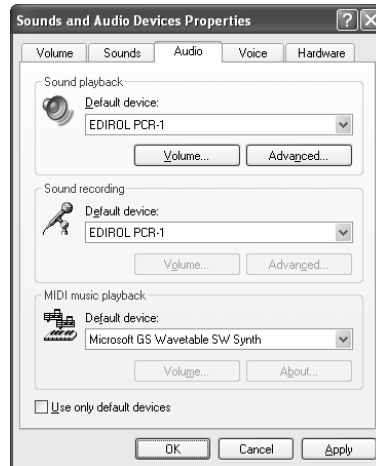

5

Close the **Sounds and Audio Devices Properties** dialog box.

Click **[OK]** to complete the settings.

MEMO

Depending on how your system is set up, the **Sounds and Audio Devices** icon may be displayed directly in the **Control Panel** (the Classic view). In this case, double-click the **Sounds and Audio Devices** icon.

MEMO

For details on the PCR-1's input/output devices, refer to **Input / output devices** (p. 44)

MEMO

For details on adjusting the audio latency and using ASIO Direct Monitor, refer to **Taking full advantage** (p. 29).

This completes settings for using the PCR-1 with an application that uses the standard Windows device settings, such as Media Player.

For details on how to make these settings, refer to the owner's manual for your software.

For details on the PCR-1's input/output devices, refer to **Input / output devices** (p. 44).

Windows 2000 / Me users

1

Open **Control Panel**.

Click the Windows **Start** button, and from the menu that appears, select **Settings | Control Panel**.

2

Open the **Sounds and Multimedia Properties**.

In **Control Panel**, double-click the **Sounds and Multimedia** icon to open the “**Sounds and Multimedia Properties**” dialog box.

3

Click the **Audio** tab.

4

For **MIDI music playback**, click the located at the right of [**Preferred device**], and select the following from the list that appears.

Sound playback	EDIROL PCR-1
Sound recording	EDIROL PCR-1



5

Close the **Sounds and Audio Devices Properties** dialog box.

Click [**OK**] to complete the settings.

This completes settings for using the PCR-1 with an application that uses the standard Windows device settings, such as Media Player.

For details on how to make these settings, refer to the owner’s manual for your software.

For details on the PCR-1’s input/output devices, refer to **Input / output devices** (p. 44).

MEMO

If the **Sound and Multimedia** icon is not displayed, click “**Show all control panel options**” in the frame at the left.

MEMO

For details on the PCR-1’s input/output devices, refer to **Input / output devices** (p. 44).

MEMO

For details on adjusting the audio latency and using ASIO Direct Monitor, refer to **Taking full advantage** (p. 29).

Windows 98 users

1

Open **Control Panel**.

Click the Windows **Start** button, and from the menu that appears, select **Settings | Control Panel**.

2

Open the **Multimedia Properties** dialog box.

In **Control Panel**, double-click the **Multimedia** icon to open the “**Multimedia Properties**” dialog box.

3

Click the **Audio** tab.

4

Specify the “**Preferred device**”.

Click the **Playback** field and **Recording** field, make the following selections from the list that appears, and click **[Apply]**.

Playback	EDIROL PCR-1
Recording	EDIROL PCR-1

5

Close the **Multimedia Properties** dialog box.

Click **[OK]** to complete the settings.

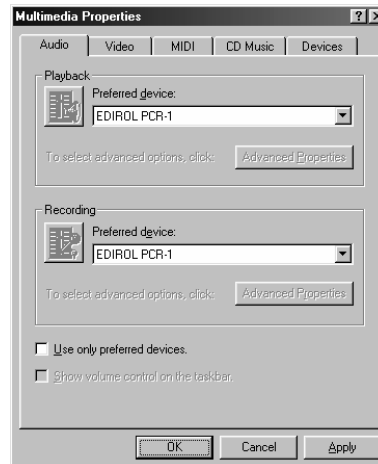

MEMO

For details on the PCR-1's input/output devices, refer to **Input / output devices** (p. 44)

MEMO

For details on adjusting the audio latency and using ASIO Direct Monitor, refer to **Taking full advantage** (p. 29).

This completes settings for using the PCR-1 with an application that uses the standard Windows device settings, such as Media Player.

For details on how to make these settings, refer to the owner's manual for your software.

For details on the PCR-1's input/output devices, refer to **Input / output devices** (p. 44).

■ Taking full advantage

Adjusting the audio latency

You can change the driver settings to adjust the **latency** of the audio. To adjust the latency, change the **Buffer Size** in the **driver settings** dialog box.

- 1** ▶ Open the “**Driver Settings**” dialog box.
 - 1.** Open “**Control Panel**”.
 - 2.** Double-click “**EDIROL PCR-1**” icon.
The **Driver Settings** dialog box will appear.
- 2** ▶ Adjust the driver buffer size.
The following setting will produce the shortest latency.
Set “**Audio Buffer Size**” to the far **left (Min)**.
- 3** ▶ Click [**OK**] to close the **driver settings** dialog box.
- 4** ▶ Restart the application that is using the PCR-1.
- 5** ▶ Play back audio data on your application.

If interruptions occur in the sound, repeat step 1 to step 5, and gradually increase the buffer size specified in step 2 until interruptions no longer occur.

MEMO

Latency is the time delay from when an application plays back audio data until the sound is actually heard from an audio device such as the PCR-1.

MEMO

In **Windows XP**, click “**Switch to Classic View**” to select Classic View on your computer. If you're not in Classic View, the EDIROL PCR-1 icon won't be shown.

In **Windows Me**, click “**Show all Control Panel Options.**”

MEMO

If you are using an application that has a function for testing audio devices, get it to perform its tests.

MEMO

Depending on the application you are using, there may be a **buffer size** or **latency** adjustment function among the audio settings of the application as well. For details, refer to the operation manual for your application.

Using ASIO Direct Monitor

If the PCR-1's **DIRECT MONITOR ON / OFF** setting (p. 97) is **AUTO**, you can control the PCR-1's Direct Monitor settings from your ASIO 2.0 compatible software.

- 1** Open the “**Driver Settings**” dialog box.
 - 1.** Open the “**Control Panel**”
 - 2.** Double-click “**EDIROL PCR-1**” icon.
The **Driver Settings** dialog box will appear.
- 2** Make the following settings.
Check the “**Use ASIO Direct Monitor**” check box.
- 3** Click [**OK**] to close the **driver settings** dialog box.

MEMO

In **Windows XP**, click “**Switch to classic view**” to switch the display to the classic view. **EDIROL PCR-1** icon will not be displayed unless the classic view is selected.

In **Windows Me**, click “**View all Control Panel options.**”

NOTE

When using **ASIO Direct Monitor**, monitoring may switch on/off at unexpected times, depending on the application settings and on the recording procedure. If this occurs, uncheck the check box in step 2 to disable **ASIO Direct Monitor**.

MEMO

Depending on your application, there may also be an **ASIO Direct Monitor** setting among the audio settings of your application. For details, refer to the operation manual for your application.

Getting Connected and Installing Drivers (Macintosh)

The installation procedure will differ depending on your system. Please proceed to one of the following sections, depending on the system you use.

- Mac OS X users (p. 31)
- Mac OS 9 users (p. 33)

Mac OS X users

■ Installing the driver

- 1** Disconnect all USB cables other than those for your keyboard and mouse, and restart your Macintosh.
- 2** Prepare the CD-ROM.
Insert the CD-ROM into the CD-ROM drive of your computer.
- 3** In the **Driver (Mac OS X)** folder of the CD-ROM, double-click **PCR1USBDriver.pkg**.
- 4** The display will indicate **“Welcome to the EDIROL PCR-1 USB Driver Installer”**. Click **[Continue]**.
- 5** The display will indicate **“Select a Destination”**.
Click the drive in which the operating system is installed to select it, and then click **[Continue]**.
- 6** The display will indicate **“Easy Install”**.
Click **Install** or **Upgrade**.
- 7** The display will indicate **“Installing this software requires you to restart your computer when the installation is done”**.
Click **[Continue Installation]**.
- 8** The display will indicate **“The software was successfully installed”**.
Click **[Restart]** to restart your computer.
This completes installation of the PCR-1 driver.
- 9** Next, make MIDI device and audio device settings.

MEMO

If the **“Authenticate”** dialog box appears during the installation, input the password and click **“OK.”**

MEMO

Select your startup disk as the drive.

MEMO

If the **“Authenticate”** dialog box appears during the installation, input the password and click **“OK.”**

■ Setting the audio device

- 1** Use the **USB cable** to connect the **PCR-1** to your **computer**.
- 2** Open “**System Preferences**” and click “**Sound**”.
- 3** In the **Sound Effects** tab, set “**Play alerts and sound effects through**” to “**EDIROL PCR-1 44.1 kHz**”.
- 4** In the **Output** tab, set “**Choose a device for sound output**” to “**EDIROL PCR-1 44.1 kHz**”.
- 5** In the **Input** tab, set “**Choose a device for sound input**” to “**EDIROL PCR-1 44.1 kHz**”.

When you have finished making settings, close the dialog box.

* *You'll need to make MIDI device settings within the sequencer you're using. For details, refer to the owner's manual for your sequencer software.*

MEMO

This unit is equipped with a protection circuit. A brief interval (a few seconds) after connecting USB cable is required before the unit will operate normally.

MEMO

Although “**44.1 kHz**” is used for the purpose of explanation within this document, this changes depending on the actual setting of the **sampling frequency select** on your PCR-1 (p. 96).

NOTE

Once set this way, all sounds from your Macintosh (including audio alerts) will be output only through the PCR-1, not from the speakers of your Macintosh.

When using the PCR-1 with your software

Before using the PCR-1 with your software, please note the following points.

- Use the USB cable to connect the PCR-1 to your computer before you start up your software.
- Do not disconnect the USB cable from the PCR-1 while your software is running.
- Quit your software before you disconnect the USB cable from the PCR-1.
- Turn off the Sleep function of your Macintosh.
- The PCR-1 will not operate in the Mac OS X Classic environment. Use the PCR-1 when the Classic environment is not running.

For details on how to make these settings, refer to the owner's manual for your software.

For details on the PCR-1's input/output devices, refer to **Input / output devices** (p. 44).

Mac OS 9 users

■ Installing the PCR-1 driver

Use either OMS or FreeMIDI as the MIDI driver.

The included **PCR-1 driver** is an add-on module for using the PCR-1 with OMS or FreeMIDI.

* *Either OMS or FreeMIDI must be installed in your Macintosh, as appropriate for the sequencer software you are using.*

If a PCR-1 is already connected to your Macintosh when you install the driver, a message like the following will appear when the Macintosh is started up. Perform the steps described below as appropriate for the message that is displayed.

If the screen indicates:

“Software needed for the USB device “PCR-1” is not available. Would you like to look for the software on the Internet?” → click **[Cancel]**.

If the screen indicates:

“The software needed to use the USB device “PCR-1” cannot be found. Please refer to the device documentation to install the necessary software”.

→ click **[OK]**.

Use the following procedure to install the PCR-1 driver.

- 1** Exit all currently running software (applications).
If you are using a virus checker or similar software, be sure to exit this as well.
- 2** Prepare the CD-ROM. Insert the CD-ROM into the CD-ROM drive.
- 3** Double-click the **PCR-1 Driver-E Installer** icon (found in the **Driver E (Mac OS 9)** folder of the CD-ROM) to start up the installer.
- 4** Verify the **Install Location**, and click **[Install]**.
- 5** If a message like the following is displayed, click **[Continue]**.
The other currently running applications will exit, and installation will continue.
- 6** A dialog box will indicate **Installation was successful**.
Click **[Restart]** to restart your Macintosh.



MEMO

OMS can be found in the **OMS 2.3.8 E** folder within the **OMS (Mac OS 9)** folder of the CD-ROM. If you would like to know more about OMS, refer to **OMS_2.3_Mac.pdf** which can be found in the same folder.

MEMO

If you install OMS or FreeMIDI after installing the PCR-1 driver, you must install the PCR-1 driver once again.

MEMO

Disconnect the PCR-1 from the Macintosh before you perform the installation.

NOTE

The installation location will be shown differently depending on your system. Make sure that you have selected the startup disk for the system you are currently using.

■ Setting the driver

If you are using FreeMIDI, proceed to **FreeMIDI settings** (p. 36).

OMS settings

1 Use the **USB cable** to connect the **PCR-1** to your **computer**.

2 From the CD-ROM, drag the **Driver E (Mac OS 9) - OMS Setting** folder into the **Opcode - OMS Applications** folder on the hard disk of your Macintosh to copy it there.



3 In the **Opcode - OMS Applications** folder where you installed OMS, double-click **OMS Setup** to start it up.



4 If a dialog box like the one shown here appears, click **[Turn It Off]**. A **confirmation** dialog box will then appear, so click **[OK]**.

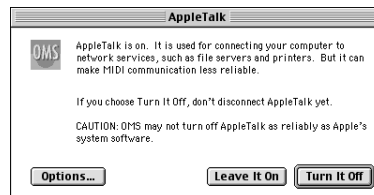

5 The **Create a New Studio Setup** dialog box will appear. Click **[Cancel]**.
If you accidentally clicked **[OK]**, click **[Cancel]** in the next screen.



MEMO

This unit is equipped with a protection circuit. A brief interval (a few seconds) after connecting the USB cable is required before the unit will operate normally.

MEMO

If you are using the PCR-1 in conjunction with other MIDI devices, make settings as described in **Readme_E.htm** located in the **Driver E (Mac OS 9)** folder of the CD-ROM.

MEMO

We recommend that you turn off **AppleTalk**, by selecting Chooser from the Apple menu.

6

Choose “**Open**” from the **File** menu.

From the **OMS Setting** folder that you copied in **step 3**, select the **PCR-1** file, and click [**Open**].

A screen like the one shown here will appear.

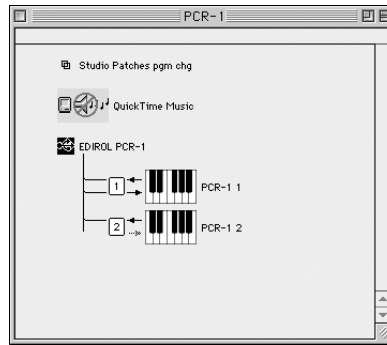

7

From the **Edit** menu, select **OMS MIDI Setup**.

In the **OMS MIDI Setup** dialog box that appears, check **Run MIDI in background**, and click [**OK**].

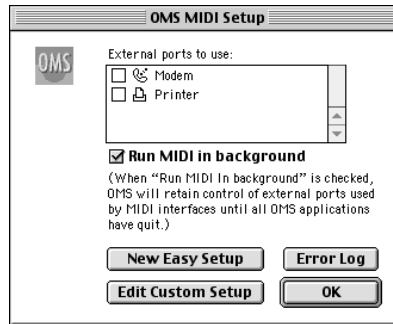

8

From the **File** menu, choose **Make Current**.

* *If you are unable to select **Make Current**, it has already been applied, and you may continue to the next step.*

A diamond mark (◊) indicate in the settings are enabled.

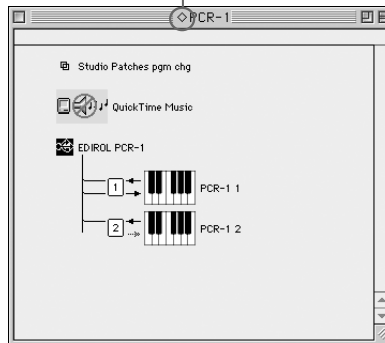

9

Verify that MIDI transmission and reception can be performed correctly. From the **Studio** menu, choose **Test Studio**.

10

Try moving the fader of the PCR-1. If the arrow beside number **1** or **2** in the diagram at right blinks, the settings have been made correctly.

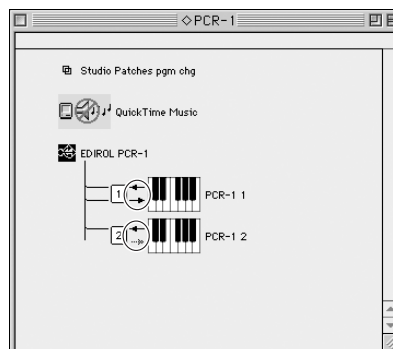

MEMO

For details on the PCR-1's input/output devices, refer to **Input / output devices** (p. 44).

11

Exit **OMS Setup**.

From the **File** menu, choose **[Exit]**. If the **AppleTalk confirmation** dialog box appears, click **[OK]** to close the dialog box.

This completes installation of the driver.

Next, make MIDI device settings in your sequencer or other software.

For details on how to make these settings, refer to the owner's manual for your software.

For details on the PCR-1's input / output devices, refer to **Input / output devices** (p. 44).

FreeMIDI settings

1

Use the **USB cable** to connect the **PCR-1** to your **computer**.

2

From the CD-ROM, drag the **Driver E (Mac OS 9) - FreeMIDI Setting** folder into the **FreeMIDI Applications** folder on the hard disk of your Macintosh to copy it there.

3

Open the **FreeMIDI Applications** folder from the location into which you installed **FreeMIDI**, and double-click the **FreeMIDI Setup** icon to start it up.

4

The first time you start up, use the following procedure.

1. A dialog box saying "**Welcome to FreeMIDI!**" will appear. Click **[Continue]**.
2. The **FreeMIDI Preferences** dialog box will appear. Click **[Cancel]**.
3. The **About Quick Setup** dialog box will appear. Click **[Cancel]**.

MEMO

This unit is equipped with a protection circuit. A brief interval (a few seconds) after connecting the USB cable is required before the unit will operate normally.

MEMO

If you are using the PCR-1 in conjunction with other MIDI devices, make settings as described in **Readme_E.htm** located in the **Driver E (Mac OS 9)** folder of the CD-ROM.

MEMO

When "**OMS is installed on this computer...**" appears, click **[FreeMIDI]**.

5 From the **File** menu, choose **Open**.

6 Select **PCR-1** from the **FreeMIDI Setting** folder you copied in **step 3**, and click [**Open**].

7 Verify that MIDI transmission and reception occur correctly.
From the **MIDI** menu, choose **Check Connections**.

8 Try moving the fader of the PCR-1. If the number **1** or **2** in the diagram at right blinks, the settings have been made correctly.

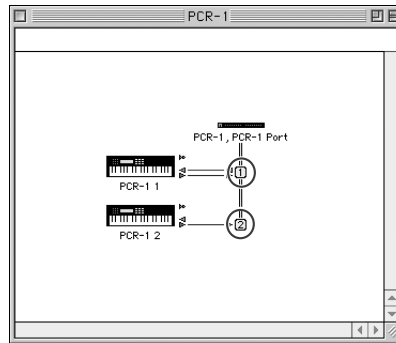

9 Once again choose the **MIDI** menu command **Check Connections** to end the test.

10 From the **File** menu, choose **Quit** to exit **FreeMIDI Setup**.

MEMO

If you are unable to select **Open**, make settings as follows.

1. From the **File** menu, choose **FreeMIDI Preference**.
2. Uncheck “**Use OMS when available.**”
3. Close FreeMIDI.
4. Return to step 4 and continue the procedure.

MEMO

For details on the PCR-1’s input/output devices, refer to **Input / output devices** (p. 44).

This completes installation of the driver.

Next, make MIDI device settings in your sequencer or other software.

For details on how to make these settings, refer to the owner’s manual for your software.

For details on the PCR-1’s input/output devices, refer to **Input / output devices** (p. 44).

■ Installing the ASIO driver

You must install the PCR-1 driver even if you will be using only audio on the PCR-1. Be sure to install the PCR-1 driver before you install the ASIO driver. (→**Installing the PCR-1 driver** (p. 33))

This section explains how to install the ASIO driver that allows the PCR-1 to be used by your sequencer software or audio editing software.

For details on installation and settings of the ASIO driver, be sure to also read the **Driver E (Mac OS 9) - Readme_E.htm** document on the CD-ROM.

The PCR-1 cannot play back audio data from the Macintosh's sound manager (such as audio CDs and alert sounds).

The ASIO driver of the PCR-1 supports the following audio input/output channels.

- Audio input 24/16 bit 1 stereo ch. (2 monaural chs.)
- Audio output 24/16 bit 1 stereo ch. (2 monaural chs.)

Here we will explain how to install the ASIO 1.0 16 bit-compatible driver.

If your ASIO-compatible software supports ASIO 2.0 or recording/playback of 24 bit audio data, using the following drivers will provide a higher quality environment.

ASIO-compatible software		Driver to use
ASIO2.0-compatible	24 bit compatible	
×	×	PCR-1 ASIO 1.0 16 bit
×	○	PCR-1 ASIO 1.0 24 bit
○	×	PCR-1 ASIO 2.0 16 bit
○	○	PCR-1 ASIO 2.0 24 bit

1

From the **Driver E (Mac OS 9) - ASIO** folder of the CD-ROM, copy [**PCR-1 ASIO1.0 16bit**] to the **ASIO Drivers** folder of the ASIO-compatible software you are using (e.g., Cubase VST, Logic Audio, Digital Performer, Metro, or SPARK LE).

2

Start up your ASIO-compatible software.

3

Open the **Audio setting** dialog box of your ASIO-compatible software, and select [**PCR-1 ASIO1.0 16bit**] as the **ASIO Device**.



ASIO (Steinberg Audio Stream In/Out Interface)
This is an audio interface standard promoted by the Steinberg Corporation. When the PCR-1 is used with ASIO-compatible software, the synchronization precision will be improved, allowing a more sophisticated music production environment.



The Audio setting dialog box will be named differently depending on your software. For details refer to the manual of your software.



For details on adjusting the audio latency and using ASIO Direct Monitor, refer to **Taking full advantage** (p. 39).

■ Taking full advantage

Adjusting the audio latency

You can change the driver settings to adjust the **latency** of the audio. To adjust the latency, change the **Buffer Size** in the **driver settings** dialog box.

- 1** ▶ Open the “**Driver Settings**” dialog box.
Open the **ASIO Control Panel** from the **Audio Settings** dialog box of your ASIO-compatible application.
- 2** ▶ Adjust the driver buffer size.
The following setting will produce the shortest latency.
Set “**Buffer Size**” to the far left (Min).
- 3** ▶ Click [OK] to close the **driver settings** dialog box.
- 4** ▶ Restart the application that is using the PCR-1.
- 5** ▶ Play back audio data on your application.

If interruptions occur in the sound, repeat step 1 to step 5, and gradually increase the buffer size specified in step 2 until interruptions no longer occur.

MEMO

Latency is the time delay from when an application plays back audio data until the sound is actually heard from an audio device such as the PCR-1.

MEMO

The name of the Audio Settings dialog box and the procedure for opening the ASIO Control Panel will differ depending on your application. For details, refer to the operation manual for your application.

MEMO

If you are using an application that has a function for testing audio devices, get it to perform its tests.

MEMO

Depending on the application you are using, there may be a buffer size or latency adjustment function among the audio settings of the application as well. For details, refer to the operation manual for your application.

Operation

The PCR-1 is a controller that transmits MIDI messages. You cannot perform using only the PCR-1 by itself. You will need to connect it to a sound module or computer.

The various controllers ([R1–R8] , [S1–S8] , [B1–B6] , [L1–L3]) can be assigned almost any message you want to get the control you need for your particular setup. For details on the messages that can be assigned, refer to **Assign MIDI messages (EDIT)** (p. 61).

Basic use

Basic connections

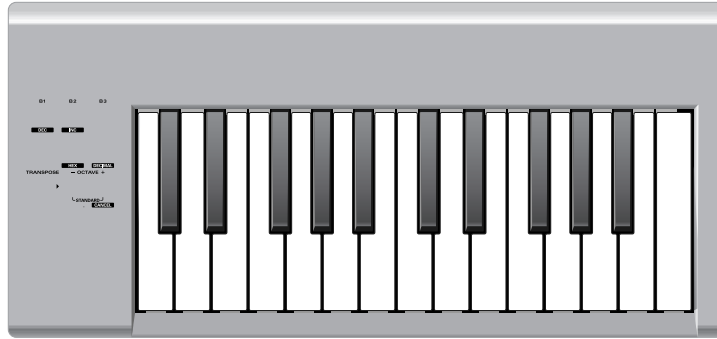

** To prevent malfunction and/or damage to speakers or other devices, always turn down the volume, and turn off the power on all devices before making any connections.*

If you connect as shown in the diagram, you will be able to monitor the playback from your software or the sound from instruments or audio devices connected to the PCR-1.

Audio and MIDI flow

■ Audio flow (Block diagram)

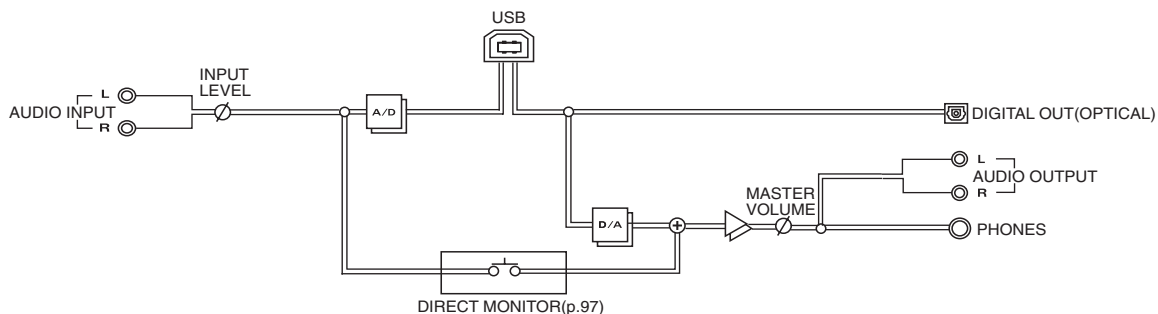

■ MIDI flow

When using a USB connection

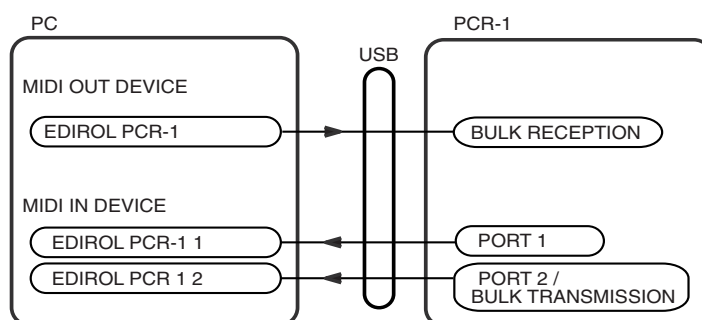

* For an explanation of the items in the diagram, refer to **Input / output devices** (p. 44).

* For details on the actual operation, refer to **Use MIDI functionality** (p. 50).

Input / output devices

In order to obtain the best performance from your software, you must make the appropriate input/output device settings.

For details on these settings, refer to the owner's manual for your software.

* *If you are unable to select the PCR-1 in the device settings for your software, it is possible that the PCR-1 driver was not installed correctly. Please reinstall the driver.*

Audio Devices

Audio output device	
EDIROL PCR-1	
	This sends audio signals from your computer to the PCR-1. If you are using Media Player you will normally choose this. You should also use this if you are using an application such as SONAR in WDM driver mode or a Direct Sound application.
MME EDIROL PCR-1 Out	
	This sends audio signals from your computer to the PCR-1. Use this if you are using an application that does not have a WDM driver mode, or if you want to use 24-bit audio with a non-ASIO application . * <i>Windows XP/2000 only</i>
Audio input devices	
EDIROL PCR-1	
	This receives audio signals sent from the PCR-1 to your computer. Normally, you should use this. You should also use this when using an application such as SONAR in WDM driver mode.
MME EDIROL PCR-1 In	
	This receives audio signals sent from the PCR-1 to your computer. Use this if you are using an application that does not have a WDM driver mode, or if you want to use 24-bit audio with a non-ASIO application . * <i>Windows XP/2000 only</i>
ASIO device	
EDIROL PCR-1	
	Select "EDIROL PCR-1" as the ASIO setting for your application if you are using the PCR-1 with an ASIO application such as Cubase. * <i>To prevent audio loops from causing oscillation or double monitoring, turn monitoring off in your application or use the ASIO Direct Monitor setting.</i>

MIDI Devices

MIDI OUT device	
PCR-1 (Mac OS 9: PCR-1 1)	
	This is the bulk reception port. When receiving bulk data into the PCR-1, select PCR-1 as the output port for your sequencer software or other program.
MIDI IN device	
PCR-1 1	
PCR-1 2	
	These ports receive messages from the keyboard, bender switch, and controllers. The port assignment determines how the keyboard, bender switch, and controllers are mapped to PCR-1 1 or PCR-1 2 . You may find it convenient to select PCR-1 1 for messages used for real-time performance on a software synthesizer or for recording on a sequencer track, and select PCR-1 2 for messages used to control a sequencer (e.g., sequencer start/stop, or track fader control). PCR-1 2 is also the bulk transmission port. When transmitting bulk data from the PCR-1 , select PCR-1 2 as the input port for your sequencer software.

Two MIDI ports

Some sequencer software that supports MIDI controllers lets you independently specify the MIDI input port used for recording MIDI tracks (the “MIDI IN port”) and the MIDI input port used to control the software (the “CTRL IN port”).

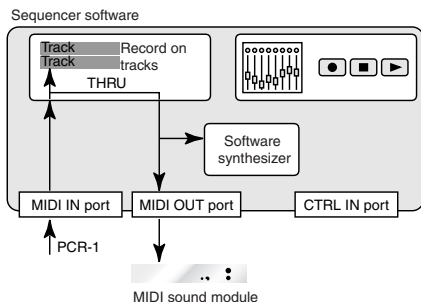

Normally, you will connect your MIDI keyboard to the MIDI IN port, and use it for recording your performance on tracks or using the MIDI Thru function of your software to play sound modules or soft synthesizers. The MIDI messages sent here have the meaning that is assigned to them by the MIDI specification. In other words, when you play the keyboard, note messages will be transmitted and recorded on the track, and the sound module that receives these messages will produce sound.

In contrast, the data received from the CTRL IN port is used to operate your software in the same way as data from your computer’s mouse or keyboard; it will not be recorded on the tracks or “thru-ed” to your sound module or soft synthesizer. The MIDI messages sent here are interpreted in a completely different way than defined in the MIDI specification.

For this reason, messages that are input from the CTRL IN port are not normally “thru-ed” to your sound module or soft synthesizer.

For example, even if you play your keyboard to send a note-on message, the software that receives this message will not produce a note; instead, it might interpret this message as meaning that the PLAY/STOP button had been pressed.

The actual operation that will occur will depend on the software you are using.

Since the same MIDI message can be interpreted in completely different ways, as described above, the software lets you specify the MIDI IN port and CTRL IN port separately so that the two types can be distinguished.

When the PCR-1 is connected via USB, you can select either of the two MIDI ports (PCR-1 1, PCR-1 2) as the output destination for MIDI messages produced by the faders, knobs, and buttons of the PCR-1.

In other words, by assigning “PCR-1 1” as your software’s MIDI IN port and “PCR-1 2” as its CTRL IN port, you can do things like using the button operations to control mixer operations in your software while using the knobs to edit your software synthesizer.

The output destination of the MIDI messages transmitted when you operate the PCR-1’s knobs, and buttons can be specified separately for each controller. (**Assign MIDI messages (EDIT)** (p. 61))

Use audio functionality

In order to play sounds on your computer from the PCR-1, you will need to first install the driver and make device settings. (→**Windows** (p. 14) , **Macintosh** (p. 31)
You must also turn on the PCR-1's USB Audio functionality. (→**USB AUDIO ON/OFF** (p. 96))

Playing sounds on your computer

Here's how you can listen to audio playback from your computer from the PCR-1 or headphones connected to the PCR-1. Play back audio data (e.g., .WAV data).

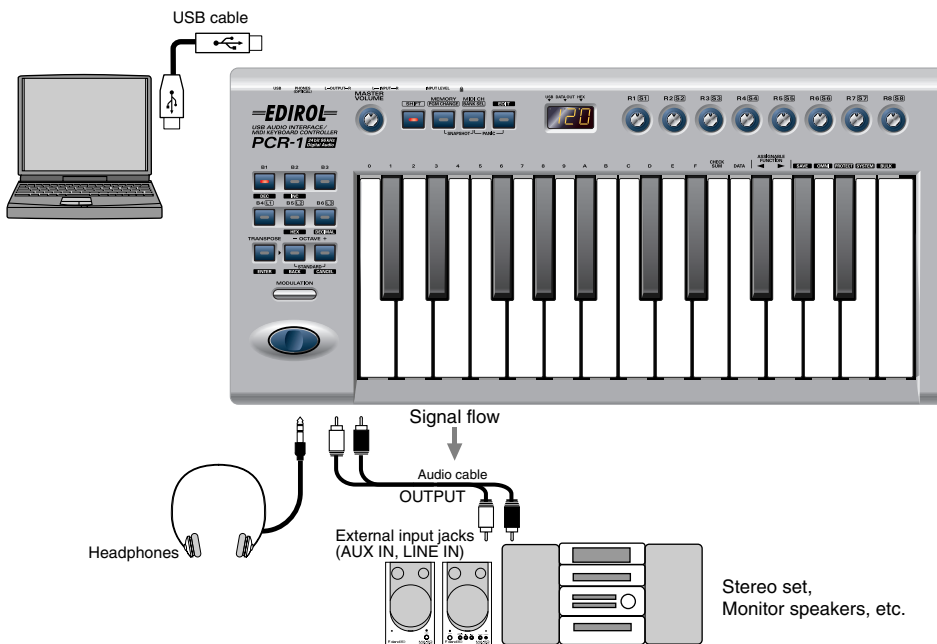

- * You will no longer hear sound from the internal speaker of your computer.
- * The PCR-1 is not equipped with its own MIDI sound generator. This means that MIDI data from your computer cannot be played by the PCR-1.
- * If the sampling frequency is set to 96 kHz REC, you will not hear the playback sound from your application. (→ **USB AUDIO MODE SETTING** (p. 96))
- * Some connection cables contain a resistor. Do not use a cable with a built-in resistor to connect with the PCR-1. Doing so may make the sound extremely weak, or inaudible. Use the cable without a built-in resistor (eg., Roland PCS series).



To prevent malfunction and/or damage to speakers or other devices, always turn down the volume, and turn off the power on all devices before making any connections.

Recording sound on your computer (using your application to record sound from external audio device)

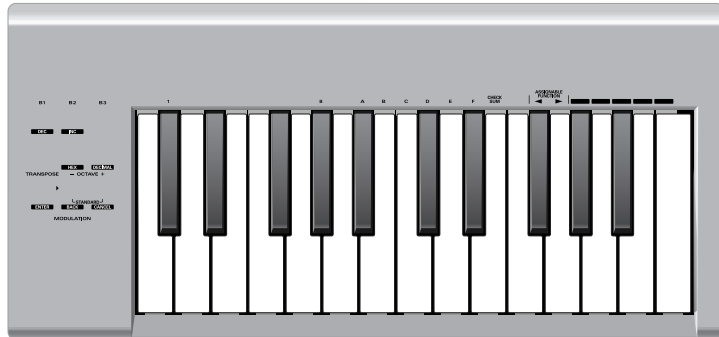

Setting

- Use the **Input volume** (p. 12) to adjust the input level. Check the input level on the application that you using.
- You must set the PCR-1's sample rate to match the sampling frequency used by your application. (→ **USB AUDIO MODE SETTING** (p. 96))
In order for the sampling frequency setting to take effect, you exit applications and disconnect the USB cable from the PCR-1, then connect it again.
- If **Direct Monitor** (p. 97) is ON, the signal input through the audio input jacks will be output from the headphone jack and the master output jacks. is ON, use the **Master volume knob** (p. 9) to adjust the monitor level.

* *Adjusting the monitor level will not change the recording level.*



Don't connect anything to input jacks you are not using.

Howling could be produced depending on the location of microphones relative to speakers.

This can be remedied by:

- 1.Changing the orientation of the microphone (s)/
- 2.Relocating microphone (s) at a greater distance from speakers/
- 3.Lowering volume levels.

Be careful of looped connections



Example of loop connection

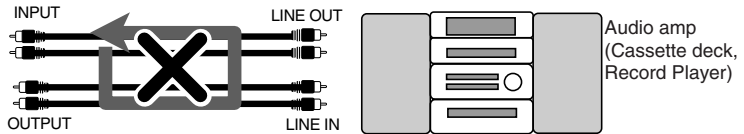



If the PCR-1 is connected as shown above to a device that outputs (“thru-s”) the input audio (such as a cassette player that is in recording mode), turning on the Input monitor switch will cause the sound to loop between the PCR-1 and the other device, causing oscillation and producing an unexpectedly high volume. Be aware that such connections may cause the system to malfunction, or your speakers to be damaged.

Use MIDI functionality

Table of operating modes

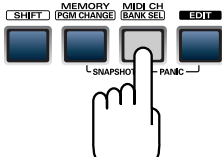
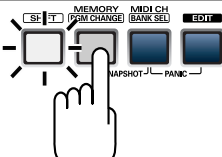
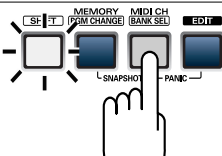
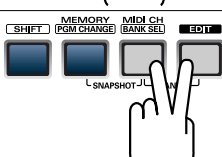
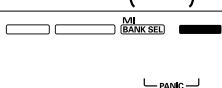
You can switch modes at any time, as shown below.

Mode	Switching modes	Explanation
PLAY mode (p. 51)	When you turn on the power, the PCR-1 will start up in PLAY mode.	Transmit MIDI messages by playing the keyboard or operating the controllers.
MIDI Channel mode (MIDI CH) (p. 53)	Press the [MIDI CH] . 	Set the transmit channel (current channel p. 53) for the keyboard and bender lever.
Program Change mode (PROGRAM CHANGE) (p. 56)	Press the [SHIFT] so it is lit, and then press the [PGM CHANGE] . 	Transmit program change messages on the current channel (p. 53).
Bank mode (BANK) (p. 57)	Press the [SHIFT] so it is lit, and then press the [BANK SEL] . 	Transmit bank select messages (MSB, LSB) on the current channel (p. 53).
Panic mode (PANIC) (p. 58)	Simultaneously, Press the [MIDI CH] and the [EDIT] . 	Stop “stuck” notes or other problems with the sound on a connected MIDI sound module.
Memory mode (MEMORY) (p. 59)	Press the [MEMORY] . 	Recall a memory set from internal memory into the current memory (p. 88).
Snapshot mode (SNAPSHOT) (p. 60)	Simultaneously, Press the [MEMORY] and the [MIDI CH] . 	Transmit the current values of controllers ([R1–R8] or [S1–S8]) at once.
Edit mode (EDIT) (p. 61)	Press the [EDIT] . 	Assign MIDI messages to the controllers, transmit/receive bulk data, or make system settings.

You are returned to Play mode once a setting or a process has been completed within the other modes. If you want to return to Play mode without completing a setting or operation, press the button for the current mode (i.e., the button that is lit). Alternatively, press the **[CANCEL]** button. The setting you were in the process of making will be discarded.

Startup mode

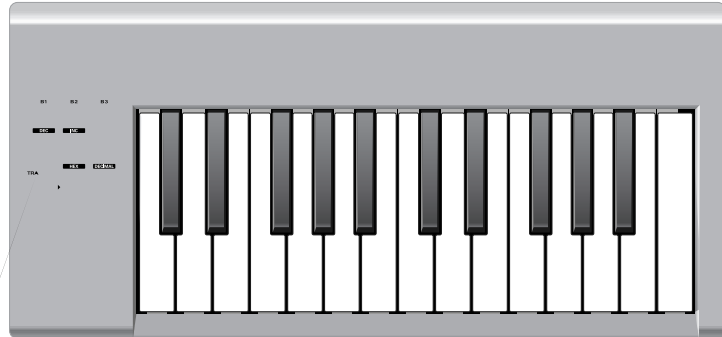

PLAY mode

When you power up the PCR-1, it will start up in PLAY mode.

In PLAY mode, playing the keyboard will transmit note messages to play the connected MIDI device.

The display will show the **current channel** (p. 53).

In PLAY mode, you can play the keyboard to produce sound on a connected sound module, and also use various other functions, such as operating the bender switch to change the pitch of the currently sounding note (Pitch Bend), using the modulation button to add vibrato (Modulation), or switching the octave (Octave Shift).

In order to send MIDI messages from the PCR-1 to your application, perform the following steps.

1

Set the MIDI channel the PCR-1 will use to transmit to the same channel on the application is using to receive on.

Use MIDI Channel mode to set the **MIDI transmit channel**.

(→**MIDI Channel mode (MIDI CH)** (p. 53)).

2

Select a **sound** on your **MIDI sound module**.

(→**"Selecting Sounds on a Sound Module"** (p. 55)).

3

Once you have finished making settings, try playing the keyboard.

When you play the keyboard in **PLAY mode**, MIDI messages are sent to the application.

* *Since the PCR-1 does not contain a sound generator, you cannot play MIDI data using the PCR-1 alone.*

Features Useful When Playing

Applying Pitch Changes to Notes (Pitch Bend)	Move the BENDER Switch (left or right) to transmit Pitch Bend messages, and apply subtle pitch changes to notes. PITCH BEND TIME (p. 97) specifies the time it is to take for the pitch bend to reach its maximum after the bender switch has been pressed. * The amount of pitch change ("bend range") depends on the settings of your sound module.
Modifying the Sound of Notes (Modulation)	Pressing the Modulation Button will transmit Modulation messages, changing the sound in real time (usually by adding a vibrato effect). MODULATION SETTING (p. 97) specifies the value of the Modulation message (CC#01) transmitted when you press the Modulation Button . * The type of change this produces in the sound depends on the settings of your sound module.
Changing Octaves (Octave Shift)	You can press [OCTAVE -] or [OCTAVE +] to raise or lower the pitch range of the keyboard (the Octave Shift function). This lets you play a wider range of notes than would normally be accessible from the 25 keys. Press [OCTAVE -] once to lower the pitch range one octave. Press it once again to lower the range an additional octave. Permissible settings for this range from -4 to 5 octaves. * [OCTAVE -] or [OCTAVE +] will light according to the current Octave Shift setting. * If you simultaneously press [OCTAVE -] and [OCTAVE +] , the Octave Shift setting will be reset to 0, restoring the normal pitch range of the keyboard.
Transpose the Pitch of the Keyboard (Transpose)	You can press [TRANPOSE] + [OCTAVE +] or [TRANPOSE] + [OCTAVE -] to transpose the keyboard in semitone steps (the Transpose function). You can transpose the pitch in a range of -12–12 (semitones). * If you press and hold [TRANPOSE] , [OCTAVE -] or [OCTAVE +] will light according to the current Transpose setting. * If you hold down [TRANPOSE] and simultaneously press [OCTAVE -] and [OCTAVE +] , the Transpose setting will be reset to 0.



While playing the keyboard, move the Bender Switch to the left to lower the pitch of the currently selected patch, or to the right to raise its pitch. This is known as **pitch bend**.

You can also apply vibrato by gently pressing the Modulation button. This is known as **modulation**.

If you press the Modulation Button and the same time move Bender Switch to the right or left, you can apply both effects at once.

Octave Shift and **Transpose** can be set independently.

To switch the PCR-1 to PLAY mode...

The PCR-1 will automatically start up in PLAY mode when you connect the PCR-1 to your computer by USB cable.

To return to PLAY mode from another mode (→**Setting the MIDI Transmit Channel** (p. 53)), press the button of the current mode (i.e., the button that is lit).

Alternatively, you can press the **[CANCEL]** button. In this case, the setting you had been making will be cancelled.

Setting the MIDI Transmit Channel

To control your sound module, set the PCR-1's **current channel** to the MIDI receive channel that's selected on your sound module. Use MIDI Channel mode to set the **current channel**.

MIDI Channel mode (MIDI CH)

1

Press the **[MIDI CH]** button.

The **[MIDI CH]** button will light. The display will show the current channel setting.

* The setting will be cancelled if you press another button instead of the **[ENTER]** button.

OMNI

If you turn the Omni setting ON, all messages will be transmitted on the **current channel** regardless of the channel that is specified for each controller.

Also, all messages will be transmitted to the **KEYBOARD PORT SET** (p. 94) regardless of the port that is specified for each controller.

1. Press the **[EDIT]** button.
The display will indicate "EDT".
2. Press the **[OMNI]** key.
The display will blink "OMN".
3. Confirm what's indicated and press the **[ENTER]** button.
4. The display will show the current setting.



0		OMNI OFF	Messages will be transmitted on the channel and port specified for each controller.
1		OMNI ON	Messages will be transmitted on the current channel from the Keyboard Port, regardless of the channel and port specified for each controller.

5. Use the **[DEC]** **[INC]** buttons or the **[0]** or **[1]** keys to select the mode.
6. Press the **[ENTER]** button.

Setting the input mode

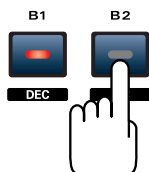

If you are not in Play mode, you can use one of two ways to input a numerical value into the PCR-1; **Decimal input mode** or **Hexadecimal input mode**.

If you want to input decimal numbers, press the **[DECIMAL]** button. If you want to input hexadecimal numbers, press the **[HEX]** button. When you connect the PCR-1 to your computer by USB cable, the PCR-1 will start up in Decimal mode.

Decimal and hexadecimal numbers correspond as follows.

Decimal:0–127

Hexadecimal:00–7F

However, for MIDI CH and PROGRAM CHANGE, the values are as follows.

	Decimal	Hexadecimal
MIDI CH	1–16	00–0F
PROGRAM CHANGE	1–128	00–7F

* Normally, the display will show three digits when using Decimal input mode. For this reason, there will be no indication of the parameter you are now inputting, and you may lose track of what you are doing. If this occurs, you can temporarily switch back to Hexadecimal mode to check the parameter you are inputting. Then switch back to Decimal mode and continue.

Selecting Sounds on a Sound Module (Sending Program Change / Bank Select Messages)

To select a sound on your MIDI sound module, transmit a Program Change in **Program Change mode**.

To select a sound from a different bank, first use **Bank mode** to transmit a Bank Select message that switches the bank. Then transmit a program change.

* *You must send the Bank Select message before sending the Program Change message.*

What is a bank?

MIDI sound modules organize their numerous sounds in various groups according to the category of sound.

These groups are called “banks.”

Program Change messages can only select sounds within the same bank, but by using these in conjunction with Bank Select messages, you can select different variations of sound.

* *The way in which sounds are organized will differ for each sound module. For details, refer to the owner's manual of the sound module you are using.*

- **Program Change Mode (PROGRAM CHANGE)** (p. 56)
- **Bank mode (BANK)** (p. 57)

Program Change Mode (PROGRAM CHANGE)

This mode lets you transmit a program change message on the **current channel** (p. 53).

1

Press the **[SHIFT]** button so it is lit.

2

Press the **[PGM CHANGE]** button.

The **[PGM CHANGE]** button will light. The display will indicate the program change that was transmitted most recently.

* The **[HEX]** or **[DECIMAL]** button will also light according to the input mode (p. 54).

Use the **[DEC]** **[INC]** buttons or the **[0]** – **[F]** keys of the keyboard to specify the program change you want to transmit.

DEC	Change the current value by -1
INC	Change the current value by +1
00–0F	The input value HEX ...00–7F DECIMAL ...1–128

3

Press the **[ENTER]** button.

The **program change** has now been transmitted.

The setting will be cancelled if you press another button instead of the **[ENTER]** button.

Bank mode (BANK)

This mode lets you transmit a bank select (MSB, LSB) message on the **current channel**. The program change message you most recently transmitted (specified) in **Program Change mode** (p. 56) will also be transmitted following the bank select message.



- 1 Press the **[SHIFT]** button so it is lit.
- 2 Press the **[BANK SEL]** button.
The **[BANK SEL]** will light. The display will indicate the most recently transmitted bank select (MSB) value.
** The **[HEX]** or **[DECIMAL]** button will also light according to the input mode (p. 54).*
- 3 First, specify the **bank select MSB** (CC#00).
Use the **[DEC]** **[INC]** buttons or the **[0]** – **[F]** keys of the keyboard to specify the bank select MSB that you want to transmit.
- 4 Press the **[ENTER]** button.
The setting will be cancelled if you press another button instead of the **[ENTER]** button.
- 5 Next, specify the bank select LSB (CC#32).
The display will indicate the most recently transmitted bank select (LSB) value.
Use the **[DEC]** **[INC]** buttons or the **[0]** – **[F]** keys of the keyboard to specify the bank select LSB that you want to transmit.
- 6 Press the **[ENTER]** button.
The bank select has now been transmitted.
The setting will be cancelled if you press another button instead of the **[ENTER]** button.

Transmitting a Reset message

(What to do if there are “stuck” MIDI notes)

If notes on a connected MIDI sound module become “stuck”, or if there is something wrong with the sound, you can execute the Panic function to solve the problem.

When you execute the Panic function, **All sound off**, **All notes off**, and **Reset all controllers** messages will be transmitted on all channels.

Panic Mode (PANIC)

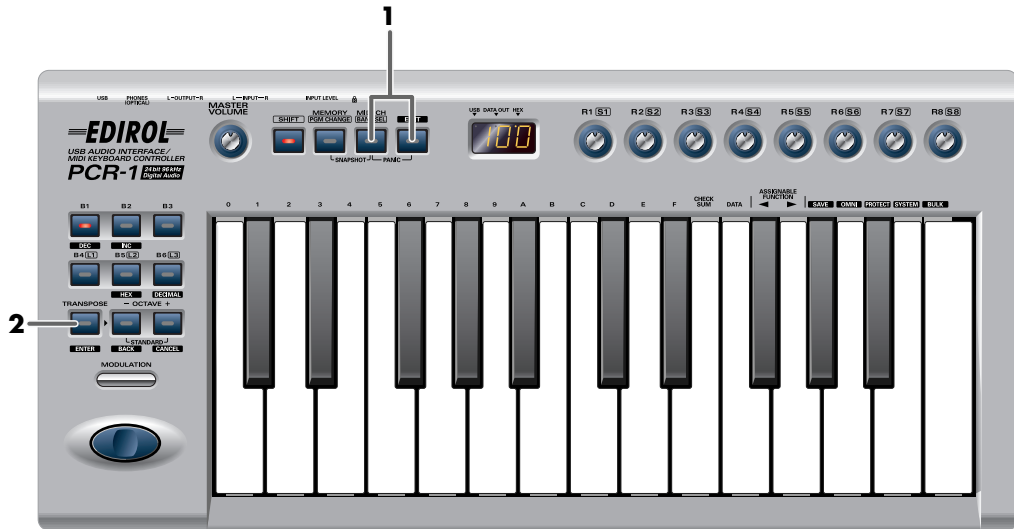

1 Simultaneously press the **[MIDI CH]** button and **[EDIT]** button.
The **[MIDI CH]** button and **[EDIT]** button will light.

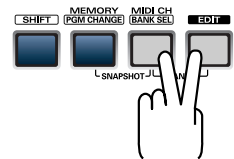

2 Press the **[ENTER]** button.
The **[MIDI CH]** button and **[EDIT]** button will blink several times.
The Panic function has now been executed.

Changing the Memory Sets

When the PCR-1 is shipped, its internal memory contains sixteen different settings. For details on the contents of each memory number, refer to **Memory sets** (p. 100).

You will use Memory mode to change the Memory sets.

Memory mode (MEMORY)

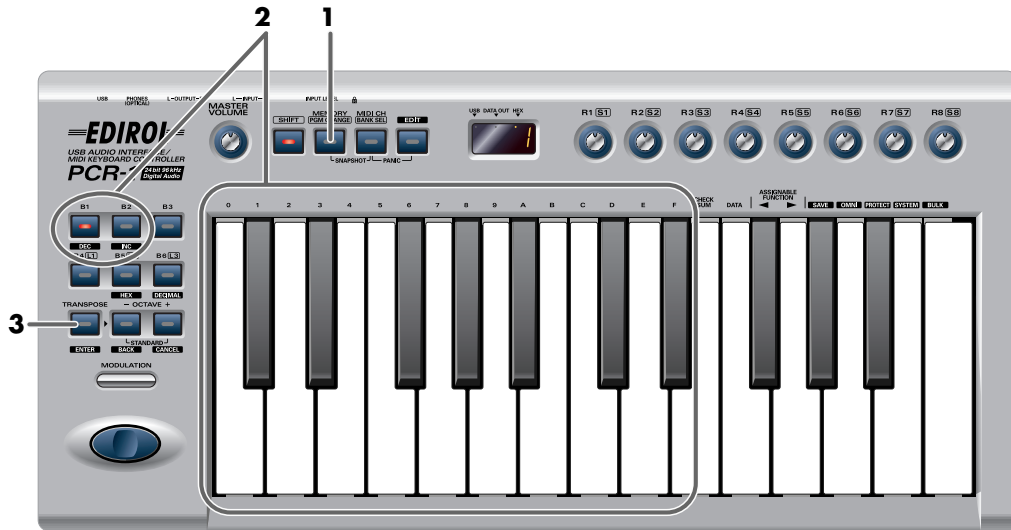

1

Press the **[MEMORY]** button.

The **[MEMORY]** button will light. The display will indicate the memory number that you selected most recently.

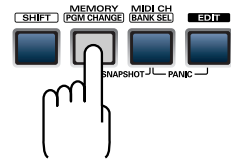

2

Use the **[DEC]** **[INC]** buttons or the **[0] – [F]** keys of the keyboard to specify the memory number that you want to recall.

3

Press the **[ENTER]** button.

The memory has now been recalled.

NOTE

The setting will be cancelled if you press another button instead of the **[ENTER]** button.

For details on customizing (editing) the controller settings, refer to **Assign MIDI messages (EDIT)** (p. 61).

If you edit the controller settings of a memory you recall, and want to keep your changes, you must save the memory before powering down the PCR-1. For the procedure, refer to **Saving a memory set (SAVE)** (p. 88).

Transmitting the current controller values all at once (SNAPSHOT)

Once you have set the various controllers to the desired settings, you can transmit a detailed description of this state in the form of a “snapshot”. When you execute this function, the current values of the controllers [R1–R8] or [S1–S8] will be transmitted.

- * When the [SHIFT] button is off, [R1–R8] will be transmitted. When the [SHIFT] button is on, [S1–S8] will be transmitted.



This is convenient when you want to record the state of these controllers together at the beginning of a song in your sequencer, as the initial values.

Snapshot mode (SNAPSHOT)



- 1 Simultaneously press the [MEMORY] button and the [MIDI CH] button.
The [MEMORY] and [MIDI CH] buttons will light.
- 2 Press the [ENTER] button.
The [MEMORY] button and [MIDI CH] button will blink several times.
The snapshot will be transmitted.

Assign MIDI messages (EDIT)

You can assign the following functions to a controller.
You will use Edit mode to assign MIDI messages.

NOTE	NOTE ASSIGN (p. 63)
AFTERTOUCH	AFTERTOUCH ASSIGN (p. 65)
CONTROL CHANGE	CONTROL CHANGE ASSIGN (p. 68)
PROGRAM CHANGE	PROGRAM CHANGE ASSIGN (p. 71)
RPN	RPN / NRPN ASSIGN (p. 74)
NRPN	RPN / NRPN ASSIGN (p. 74)
Sys Ex	Sys Ex. ASSIGN (p. 77)
TEMPO (20-250)	TEMPO ASSIGN (p. 85)

You can copy assigned messages to another controller, or cancel an assignment. For details, refer to **Copying a MIDI message assignment (ASSIGN COPY)** (p. 86) or **Canceling a MIDI message assignment (NO ASSIGN)** (p. 87).

* If you want to assign a single-byte system message (system realtime message, tune request) or a freely specified message of up to 24 bytes, refer to **Sys Ex. ASSIGN** (p. 77).

Edit mode (EDIT)

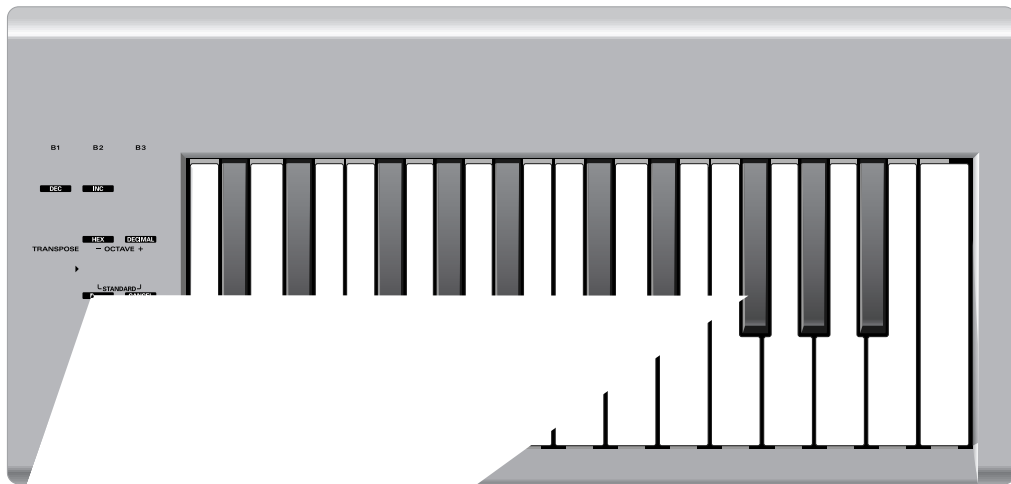

■ NOTE ASSIGN

Here's how to assign a Note message to a controller. In addition to being used to play sounds, note messages can also be used to control a sequencer.

Mode	Keyboard	Velocity	Port
------	----------	----------	------

Basic mode

- 1** Press the **[EDIT]** button.
The display will indicate "EDT."
- 2** Slightly move the controller to which you want to assign a Note message. In the case of a button, press that button.
The display will indicate the number of the selected controller.
- 3** Verify that the display shows the correct controller number, and press the **[ENTER]** button.
- 4** Press an **ASSIGNABLE FUNCTION** key () on the keyboard enough times to get "NT0" to appear in the display.
- 5** Press the **[ENTER]** button.
The display will indicate "C-."
- 6** Input the channel. Use the **[DEC]** **[INC]** buttons or the **[0]**–**[F]** keys to specify the channel.
- 7** Press the **[ENTER]** button.
The display will indicate "N-."
- 8** Input the note number. Use the **[DEC]** **[INC]** buttons or the **[0]** – **[F]** keys to specify the note number.
- 9** Press the **[ENTER]** button.
- 10** If you are making an assignment for a button, specify the button mode.
(→**Specifying the button mode** (p. 62))

Advanced mode 1

Advanced mode 1 of NOTE ASSIGN lets you specify the velocity value in addition to the items of Basic mode.

1. Press the **[EDIT]** button.
2. Slightly move the controller to which you want to assign a Note message. In the case of a button, press that button.
The display will indicate the number of the selected controller.
3. Verify that the display indicates the correct controller, and press the **[ENTER]** button.
4. Using the **ASSIGNABLE FUNCTION** keys (**◀ ▶**) on the keyboard, get "NT0" to appear in the display, then press the **[1]** key of the keyboard.
5. Press the **[ENTER]** button.
6. Input the channel.
7. Press the **[ENTER]** button.
8. Input the note number.
9. Press the **[ENTER]** button.
The display will indicate "V-."
10. Input the velocity.
11. Press the **[ENTER]** button.
The display will indicate "P-."
12. Specify the output port. (→**Specifying the port** (p. 62))
13. If you are making an assignment for a button, specify the button mode.
(→**Specifying the button mode** (p. 62))

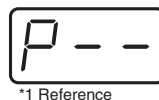
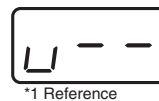

- If you set **[S1] – [S8]** , **[R1] – [R8]** to NOTE ASSIGN, setting the controller to the maximum position will transmit the specified velocity value.
- If you assign this to **[B1] – [B6]** , the specified velocity value will be transmitted when you turn the controller on. When you turn the controller off, a note message with a velocity value of 0 will be transmitted.

■ AFTERTOUCHESSIGN

Here's how to assign an Aftertouch message to a controller.

Mode	Keyboard	Message	Value range	Port
Basic mode	0	Channel Pressure	0-127 (00-7FH)	Port 1
Advanced mode 1	1	Channel Pressure	Assignable	Assignable
Advanced mode 2	2	Polyphonic Key Pressure	0-127 (00-7FH)	Port 1
Advanced mode 3	3	Polyphonic Key Pressure	Assignable	Assignable

Basic mode

1

Press the **[EDIT]** button.

The display will indicate "EDT."

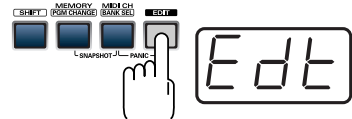

2

Slightly move the controller to which you want to assign an Aftertouch message. In the case of a button, press that button.

The display will indicate the number of the selected controller.



3

Verify that the display shows the correct controller number, and press the **[ENTER]** button.

4

Press an **ASSIGNABLE FUNCTION** key (**◀▶**) on the keyboard enough times to get "AT0" to appear in the display.

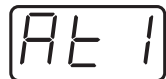

5

Verify that the display is correct, and press the **[ENTER]** button.

The display will indicate "C--".



*1 Reference

6

Input the channel. Use the **[DEC]** **[INC]** buttons or the **[0]** – **[F]** keys to specify the channel.

7

Press the **[ENTER]** button.

8

If you are making an assignment for a button, specify the button mode.

(→**Specifying the button mode** (p. 62))

*1 The -- area displays the currently set value. If it has not been set, the default setting will be displayed. Even if you change the type or mode of the MIDI message that is assigned, the default setting will be displayed. This will be lit if the value is the same as the currently set value, or will blink if the value is different.

Advanced mode 1–3

Advanced mode 1 of AFTERTOUCH ASSIGN lets you specify the upper and lower limits of the aftertouch value in addition to the items of Basic mode. Advanced modes 2 and 3 let you specify an aftertouch message for an individual note (Polyphonic Key Pressure) instead of specifying the channel.

1. Press the **[EDIT]** button.
2. Slightly move the controller to which you want to assign an Aftertouch message. In the case of a button, press that button.
The display will indicate the number of the selected controller.
3. Verify that the display indicates the correct controller, and press the **[ENTER]** button.
4. Using the **ASSIGNABLE FUNCTION** keys (◀▶) on the keyboard, get "AT0" to appear in the display, then press the **[1] - [3]** key of the keyboard.
The display will indicate the selected mode. 
5. Press the **[ENTER]** button.
6. Input the channel.
7. Press the **[ENTER]** button.
8. If you are using Advanced modes 2 or 3, input the note number.
9. If you are using Advanced modes 2 or 3, press the **[ENTER]** button.
10. If you are using Advanced modes 1 or 3, specify the upper limit and lower limit of the value as described in **Specifying the range of values (upper and lower limits)** (p. 67) , and specify the output port.
11. If you are using Advanced modes 1 or 3, specify the output port.(→**Specifying the port** (p. 62))
12. If you are making an assignment for a button, specify the button mode.
(→**Specifying the button mode** (p. 62))

Specifying the range of values (upper and lower limits)

If in Edit mode you selected an Assign type (p. 61) that lets you specify the range of values, you will need to specify the upper limit and lower limit of the value.

* Normally, when using Decimal input mode, the value you are specifying appears in the display as a three digit number. This means that there is no indication of which parameter you are currently entering, so you may lose track of what you are doing. If this occurs, you can temporarily switch to Hex input mode to check the parameter that you are now inputting. Then switch back to Decimal input mode and continue. (→**Setting the input mode** (p. 54))

1. The following display will appear.
2. Use the **[DEC]** **[INC]** buttons or the **[0]** – **[F]** keys to specify the upper limit.
3. Press the **[ENTER]** button.
The following display will appear.
4. Use the **[DEC]** **[INC]** buttons or the **[0]** – **[F]** keys to specify the lower limit.
5. Press the **[ENTER]** button.



*1 Reference



*1 Reference

*1 The -- area displays the currently set value. If it has not been set, the default setting will be displayed. Even if you change the type or mode of the MIDI message that is assigned, the default setting will be displayed. This will be lit if the value is the same as the currently set value, or will blink if the value is different.

■ CONTROL CHANGE ASSIGN

Here's how to assign a control change message to a controller.

Mode	keyboard	Value range	Port
Basic mode	0	00-7FH	PORT 1
Advanced mode 1	1	Assignable	Assignable
Advanced mode 2	2	Simulates a rotary encoder	Assignable

Basic mode

1

Press the **[EDIT]** button.

The display will indicate "EDT".

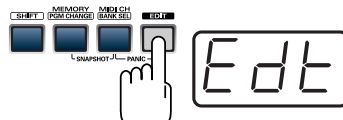

2

Slightly move the controller to which you want to assign a Control Change message. In the case of a button, press that button.

The display will indicate the number of the selected controller.

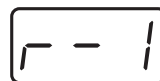

3

Confirm what's indicated, and press the **[ENTER]** button.

4

Press an **ASSIGNABLE FUNCTION** key (◀▶) on the keyboard enough times to get "CC0" to appear in the display.



5

Confirm what's indicated, and press the **[ENTER]** button.

The display will indicate "C--".

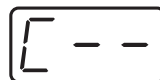

*1 Reference

6

Input the channel. Use the **[DEC]** **[INC]** buttons or the **[0]** – **[F]** keys to specify the channel.

7

Press the **[ENTER]** button.

The display will indicate "N--".

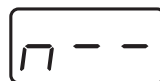

*1 Reference

8

Use the **[DEC]** **[INC]** buttons or the **[0]** – **[F]** keys to specify the control change number.

9

Press the **[ENTER]** button.

10

If you are making an assignment for a button, specify the button mode.

(→**Specifying the button mode** (p. 62))

Advanced mode 1

Advanced mode 1 of CONTROL CHANGE ASSIGN lets you specify the upper and lower limits of the control change value in addition to the items of Basic mode.

1. Press the **[EDIT]** button.
2. Slightly move the controller to which you want to assign a Control Change message. In the case of a button, press that button.
The display will indicate the number of the selected controller.
3. Confirm what's indicated, and press the **[ENTER]** button.
4. Using the **ASSIGNABLE FUNCTION** keys (◀▶) on the keyboard, get "CC0" to appear in the display, then press the **[1]** key of the keyboard.
The display will indicate "CC1".
5. Press the **[ENTER]** button.
6. Input the channel.
7. Press the **[ENTER]** button.
8. Input the control change number.
9. Press the **[ENTER]** button.
10. Specify the range of values. (→**Specifying the range of values (upper and lower limits)** (p. 67))
The display will indicate "P--".
11. Specify the output port. (→**Specifying the port** (p. 62))
12. If you are making an assignment for a button, specify the button mode.
(→**Specifying the button mode** (p. 62))



*1 Reference

*1 The -- area displays the currently set value. If it has not been set, the default setting will be displayed. Even if you change the type or mode of the MIDI message that is assigned, the default setting will be displayed. This will be lit if the value is the same as the currently set value, or will blink if the value is different.

Advanced mode 2

Advanced mode 2 simulates the operation of a conventional rotary encoder. If this is assigned to a controller, moving that controller toward the right (upward) of center will have the same effect as turning the encoder clockwise, and moving the controller toward the left (downward) of center will have the same effect as turning the encoder counterclockwise. As the controller is moved further away from the center, the result will be the same as if the rotary encoder were moved more quickly.

You can assign advanced mode 2 to a button, but it will not function.

1. Press the **[EDIT]** button.
2. Slightly move the controller to which you want to assign a Control Change message. The display will indicate the number of the selected controller.
3. Confirm what's indicated, and press the **[ENTER]** button.
4. Using the **ASSIGNABLE FUNCTION** keys (**◀ ▶**) on the keyboard, get "CC0" to appear in the display, then press the **[2]** key of the keyboard. The display will indicate "CC2".
5. Press the **[ENTER]** button.
6. Input the channel.
7. Press the **[ENTER]** button.
8. Input the control change number. Use the **[DEC]** **[INC]** buttons or the **[0]** – **[F]** keys to specify the control change number.
9. Press the **[ENTER]** button. The display will indicate "P--".
10. Specify the output port. (→**Specifying the port** (p. 62))

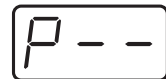

*1 Reference

PROGRAM CHANGE ASSIGN

Here's how to assign a program change message to a controller.

Mode	Number	Effect	Bank	Port
Basic mode	0	Fixed value	Not output	PORT 1
Advanced mode 1	1	Assignable range of values	Not output	PORT 1
Advanced mode 2	2	Fixed value	Output	Assignable
Advanced mode 3	3	PC DEC	Not output	PORT 1
Advanced mode 4	4	PC INC	Not output	PORT 1

Basic mode

1

Press the **[EDIT]** button.

The display will indicate "EDT."

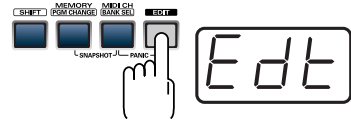

2

Slightly move the controller to which you want to assign a Program Change message. In the case of a button, press that button.

The display will indicate the number of the selected controller.



3

Confirm what's indicated, and press the **[ENTER]** button.

4

Press an **ASSIGNABLE FUNCTION** key (**◀▶**) on the keyboard enough times to get "PC0" to appear in the display.



5

Confirm what's indicated, and press the **[ENTER]** button.

The display will indicate "C--".

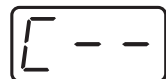

*1 Reference

6

Input the channel. Use the **[DEC]** **[INC]** buttons or the **[0] – [F]** keys to specify the channel.

7

Press the **[ENTER]** button.

The display will indicate "N--".

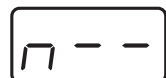

*1 Reference

8

Use the **[DEC]** **[INC]** buttons or the **[0] – [F]** keys to specify the program change number.

9

Press the **[ENTER]** button.

* If you assign Basic mode to **[S1] – [S8]** or **[R1] – [R8]**, moving the controller up to the maximum position will transmit the assigned program change messages.

*1 The -- area displays the currently set value. If it has not been set, the default setting will be displayed. Even if you change the type or mode of the MIDI message that is assigned, the default setting will be displayed. This will be lit if the value is the same as the currently set value, or will blink if the value is different.

Advance mode 1, 2

Advanced mode 1 of PROGRAM CHANGE ASSIGN lets you specify the upper and lower limits of the program change value. Advanced mode 2 lets you transmit BANK LSB/MSB settings in addition to the program change.

1. Press the **[EDIT]** button.
2. Slightly move the controller to which you want to assign a Program Change message. In the case of a button, press that button. The display will indicate the number of the selected controller.
3. Confirm what's indicated, and press the **[ENTER]** button.

Advanced mode 1

—Specifying the range of values

4. Using the **ASSIGNABLE FUNCTION** keys (**◀▶**) on the keyboard, get "PC0" to appear in the display, then press the **[1]** key of the keyboard.
5. Press the **[ENTER]** button.
6. Input the channel.
7. Press the **[ENTER]** button.
8. Specify the range of values. (→**Specifying the range of values (upper and lower limits)** (p. 67))

Advanced mode 2

—Transmitting bank data

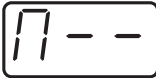
4. Using the **ASSIGNABLE FUNCTION** keys (**◀▶**) on the keyboard, get "PC0" to appear in the display, then press the **[2]** key of the keyboard.
5. Press the **[ENTER]** button.
6. Input the channel.
7. Press the **[ENTER]** button.
8. Specify the bank select MSB (CC#00). Use the **[DEC]** **[INC]** buttons or the **[0]** – **[F]** keys to specify the MSB.
 

*1 Reference
9. Press the **[ENTER]** button.
10. Specify the bank select LSB (CC#32). Use the **[DEC]** **[INC]** buttons or the **[0]** – **[F]** keys to specify the LSB.
 

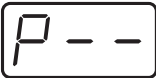
*1 Reference
11. Press the **[ENTER]** button.
12. Input the program change number.
13. Press the **[ENTER]** button.
The display will indicate "P--".
 

*1 Reference
14. Specify the output port. (→**Specifying the port** (p. 62))

Advanced modes 3 and 4

Advanced mode 3 lets you assign the Program Change Decrement function (**PC DEC**) to a controller.

Advanced mode 4 lets you assign the Program Change Increment function (**PC INC**) to a controller.

1. Press the **[EDIT]** button.
2. Slightly move the controller to which you want to assign Program Change DEC/INC. In the case of a button, press that button.
The display will indicate the number of the selected controller.
3. Confirm what's indicated, and press the **[ENTER]** button.
4. Using the **ASSIGNABLE FUNCTION** keys (**◀ ▶**) on the keyboard, get "PC0" to appear in the display, then press the **[3]** or **[4]** key of the keyboard.
5. Press the **[ENTER]** button.

Program Change Decrement function (PC DEC)

This transmits a program change that is one less than the previously transmitted program change number.

Program Change Increment function (PC INC)

This transmits a program change that is one greater than the previously transmitted program change number.

The **PC DEC** or **PC INC** is transmitted on the current channel, just as in **Program Change Mode (PROGRAM CHANGE)** (p. 56). The value that is actually transmitted will appear in the display.

- In the explanation here, the "previously transmitted program number" refers to the one that was last transmitted by Advanced Mode 3 or 4 or in **Program Change Mode (PROGRAM CHANGE)** (p. 56).
- Program changes transmitted by basic mode or advanced modes 1 and 2 will not affect the **increment/decrement** functions.

■ RPN / NRPN ASSIGN

Here's how you can assign an RPN or NRPN message to a controller.

Mode	Keyboard	Data entry MSB (CC#6) range	Data entry LSB (CC#38) range	Port
Basic mode	0	0-127 (00-7FH)	Not transmitted	PORT 1
Advanced mode 1	1	Assignable	0-127 (00-7FH)	Assignable

1

Press the **[EDIT]** button.

The display will indicate "EDT".

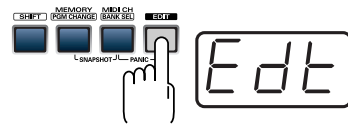

2

Slightly move the controller to which you want to assign an RPN or NRPN message. In the case of a button, press that button.

The display will indicate the number of the selected controller.



3

Confirm what's indicated, and press the **[ENTER]** button.

4

Press an **ASSIGNABLE FUNCTION** key (◀▶) on the keyboard enough times to get "RP0" to appear in the display.



* If you want to assign an NRPN message, press the **[NRPN]** key. The following procedure is the same as for RPN.



5

Confirm what's indicated, and press the **[ENTER]** button.

The display will blink "C--".

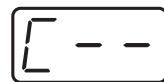

*1 Reference

6

Input the channel. Use the **[DEC]** **[INC]** buttons or the **[0]** – **[F]** keys to specify the channel.

7

Press the **[ENTER]** button.

8

Use the **[DEC]** **[INC]** buttons or the **[0]** – **[F]** keys to specify the RPN MSB (CC#101) or NRPN MSB (CC#99).

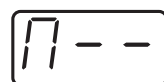

*1 Reference

9

Press the **[ENTER]** button.

10

Use the **[DEC]** **[INC]** buttons or the **[0]** – **[F]** keys to specify the RPN LSB (CC#100) or NRPN LSB (CC#98).

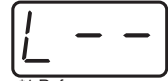

*1 Reference

11

Press the **[ENTER]** button.

12

If you are making an assignment for a button, specify the button mode.

(→**Specifying the button mode** (p. 62))

*1 The -- area displays the currently set value. If it has not been set, the default setting will be displayed. Even if you change the type or mode of the MIDI message that is assigned, the default setting will be displayed. This will be lit if the value is the same as the currently set value, or will blink if the value is different.

Advanced mode

In Advanced mode for RPN/NRPN, you can specify the upper and lower limit of the data entry MSB (CC#06) value when the RPN/NRPN message is transmitted, as well as the various settings available in Basic mode.

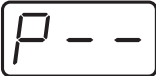
1. Press the **[EDIT]** button.
2. Slightly move the controller to which you want to assign the RPN or NRPN message. In the case of a button, press that button.
The display will indicate the number of the selected controller.
3. Confirm what's indicated, and press the **[ENTER]** button.
4. Using the **ASSIGNABLE FUNCTION** keys (**◀ ▶**) on the keyboard, get "RP0" to appear in the display, then press the **[1]** key of the keyboard.
* *If you want to assign an NRPN message, press the **[NRPN]** key. The following procedure is the same as for RPN.*
5. Press the **[ENTER]** button.
6. Input the channel. Use the **[DEC]** **[INC]** buttons or the **[0] – [F]** keys to specify the channel.
7. Press the **[ENTER]** button.
8. Use the **[DEC]** **[INC]** buttons or the **[0] – [F]** keys to specify the RPN MSB (CC#101) or NRPN MSB (CC#99).
9. Press the **[ENTER]** button.
10. Use the **[DEC]** **[INC]** buttons or the **[0] – [F]** keys to specify the RPN LSB (CC#100) or NRPN LSB (CC#98).
11. Press the **[ENTER]** button.
12. Specify the lower limit of the data entry MSB (CC#06) value. (→**Specifying the range of values (upper and lower limits)** (p. 67))
The display will indicate "P-."

13. Specify the output port. (→**Specifying the port** (p. 62))
14. If you are making an assignment for a button, specify the button mode.
(→**Specifying the button mode** (p. 62))

*1 Reference

■ Sys Ex. ASSIGN

Here's how you can assign a system exclusive message to a controller. Advanced mode 2 lets you assign a single-byte system message (System realtime message, tune request).

Advanced modes 3 and 4 let you assign any desired message. (Input up to 24 bytes)

Mode	Key-board	Mode	Value range	Required ending	Notes/restrictions
Basic mode	0	Sys Ex. message	Default range	Input F7	1st byte fixed at F0
Advanced mode 1	1	Sys Ex. message	Assignable	Input F7	1st byte fixed at F0
Advanced mode 2	2	Single byte system message	–	–	[0–5, 7, 9, D, E] [DATA][CHECKSUM] buttons are invalid
Advanced mode 3	3	Any desired MIDI message	Default range	Specified number of bytes	[CHECKSUM] button is invalid
Advanced mode 4	4	Any desired MIDI message	Assignable	Specified number of bytes	[CHECKSUM] button is invalid

Sys Ex. ASSIGN can calculate the checksum automatically, and lets you specify a variable (data) range or embed a channel/block number within the message. (**Sys Ex. ASSIGN items** (p. 79))

In Sys Ex. ASSIGN, the input mode will be HEX mode.

1

Press the **[EDIT]** button.

The display will indicate "EDT".

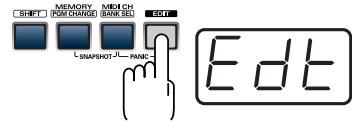

2

Slightly move the controller to which you want to assign the system exclusive message. In the case of a button, press that button.

The display will indicate the number of the selected controller.



3

Confirm what's indicated, and press the **[ENTER]** button.

4

Press an **ASSIGNABLE FUNCTION** key (◀▶) on the keyboard enough times to get "SE0" to appear in the display.

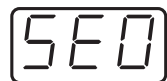

5

If you want to select an Advanced mode, press a key from **[1]** to **[4]**.

The selected mode will blink in the display.

6

Confirm what's indicated, and press the **[ENTER]** button.

Then continue with the procedure described in Basic mode or Advanced mode (p. 78).

For some actual examples of settings, refer to **Examples of assigning system exclusive messages** (p. 82).

For Basic mode or Advanced mode 1

The display will blink "F0", which is the first byte (starting status byte) of a system exclusive message. (This cannot be changed.)

7. Confirm what's indicated, and press the [ENTER] button.
8. Use the [0] – [F] keys to input the second byte.
9. Press the [ENTER] button.
10. Input the third and subsequent bytes in the same way.
11. When you have finished inputting the message, use the keyboard to enter [F] and [7], specifying the ending status byte "F7".
12. Press the [ENTER] button.
13. If Advanced mode1, specify the range of values. (→**Specifying the range of values (upper and lower limits)** (p. 67))
14. Specify the output port. (→**Specifying the port** (p. 62))
15. If you are making an assignment for a button, specify the button mode. (→**Specifying the button mode** (p. 62))



For Advanced mode 2

The display will indicate "F-."

7. Use the [6], [8], [A] – [C], [F] keys to specify the system message.
8. Press the [ENTER] button.
9. Specify the output port. (→**Specifying the port** (p. 62))

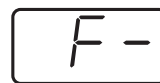

For Advanced modes 3 or 4

The display will indicate "L-".

7. Use the [0] – [F] keys of the keyboard to specify the number (decimal) of bytes you want to input.
8. Press the [ENTER] button.
9. Use the [0] – [F] keys to input the first byte.
10. Press the [ENTER] button.
11. Input the second and subsequent bytes in the same way.
12. After you have input the number of bytes you specified in step 7, the PCR-1 will check whether the messages you've input are indeed valid MIDI messages. If there is a problem, the display will indicate "ERR".
In this case, you should press the [ENTER] button, which takes you back to step 7, where you can input the values over again.
13. If Advanced mode4, specify the range of values. (→**Specifying the range of values (upper and lower limits)** (p. 67))
14. Specify the output port. (→**Specifying the port** (p. 62))
15. If you are making an assignment for a button, specify the button mode. (→**Specifying the button mode** (p. 62))

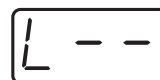

*1 Reference

■ Sys Ex. ASSIGN items

- Specifying the checksum (p. 79)
- Specifying the location of the data (p. 80)
- Inputting channel/block data (p. 81)

Specifying the checksum

The PCR-1 can automatically calculate the checksum of a system exclusive message and embed it in the message. In order to use this function, you must use the following procedure to specify the starting location from which the checksum is calculated, and the location at which the checksum is inserted. You can also select the type of checksum.

For an actual example, please read the Sys Ex.ASSIGN section **Bend Pitch Control** (p. 84).

1. Press the **[CHECKSUM]** key before you input the byte at which checksum calculation should begin.

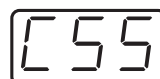

The display will indicate "CSS" (Checksum Start).

If you press the **[CHECKSUM]** key once again, "CSS" (Checksum Start) will be cancelled.

2. Press the **[ENTER]** button.

3. Continue inputting data.

4. Press the **[CHECKSUM]** key at the location where the checksum should be inserted.



The display will indicate "CS1" (Checksum type 1).

5. Press the **[ENTER]** button.

Checksum types

There are two types of checksum, as follows.

1		CHECKSUM TYPE 1	This is the method used by Roland and most other manufacturers
2		CHECKSUM TYPE 2	Select this if the method other than type 1 is used

Switching the type

If you want to switch to **type 2**, press the **[2]** key after you press **[CHECKSUM]** in step 4.

To switch back to **type 1**, press the **[1]** key.

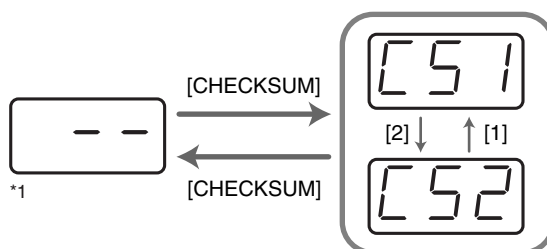

Specifying the location of the data

Here's how to specify the location and data type of the variable portion (data) within a system exclusive message.

The range of data values will be the default range in the case of Basic mode or Advanced mode 3. In the case of Advanced modes 1 and 4, you can specify the range of data values.

For an actual example, please read the Sys Ex. ASSIGN section **Master Volume** (p. 83).

1. Press the **[DATA]** key at the location where you want to input the data.
The display will indicate "DT0".
2. Use the **[0]** – **[4]** keys to select the type of data.

Data number	Data type	Default range	Target of range setting	Example (specified upper/lower limits)
DT0	7bit	00H–7F		

* In the case of DT1–DT4 (data consisting of two or more bytes), a data area will automatically be allocated for the next byte, and "-DT" will be displayed. (This cannot be changed.)

3. Press the **[ENTER]** button.
4. If you selected DT1 through DT4, the display will indicate "-DT".
Press the **[ENTER]** button.

Inputting channel/block data

If a system exclusive message includes a channel or GS block number, here's how to specify the type and the value of the upper bits. For the channel and block number, the setting of the **current channel** will be inserted as the lower bits. (The block number is not actually a channel, but corresponds to the “part” within a GS sound module. On the PCR-1, this corresponds to the channel for the sake of convenience.)

Current channel	1	2	3	4	5	6	7	8	9	10	11	12	13	14	15	16
CH	0	1	2	3	4	5	6	7	8	9	A	B	C	D	E	F
BL	1	2	3	4	5	6	7	8	9	0	A	B	C	D	E	F

For an actual example, refer to **Bend Pitch Control** (p. 84) in the section on the Edit Mode.

1. Press the **[DATA]** key several times at the location where you want to input the channel/block number, to select “0CH” for the channel or “0BL” for the block.

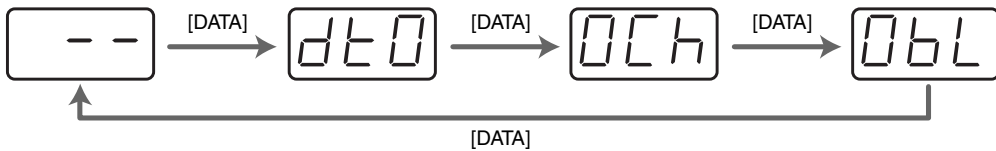

2. Use the **[0] – [7]** keys to input the value of the upper four bits. The “0” in the display will change to the numerical value that you input.
3. Press the **[ENTER]** button.

■ Examples of assigning system exclusive messages

- **GM2 System On** (p. 82)
- **Master Volume** (p. 83)
- **Bend Pitch Control** (p. 84)

GM2 System On

F0 7E 7F 09 03 F7

Here's how to assign a GM2 System On system exclusive message in **Basic mode**.

1. Press the **[EDIT]** button.
The display will indicate "EDT".
2. Slightly move the controller to which you want to assign the system exclusive message. In the case of a button, press that button.
The display will indicate the number of the selected controller.
3. Confirm what's indicated, and press the **[ENTER]** button.
4. Press an **ASSIGNABLE FUNCTION** key (◀▶) on the keyboard enough times to get "SE0" to appear in the display.
5. Confirm what's indicated, and press the **[ENTER]** button.
The display will indicate "F0", which is the first byte (beginning status) of a system exclusive message. This cannot be changed. (This cannot be changed.)
6. Confirm what's indicated, and press the **[ENTER]** button.
7. Use the **[7]** and **[E]** keys to input the second byte "7E".
8. Confirm what's indicated, and press the **[ENTER]** button.
9. Use the **[7]** and **[F]** keys to input the third byte "7F".
10. Confirm what's indicated, and press the **[ENTER]** button.
Input the fourth and fifth bytes in the same way.
11. Finally, use the **[F]** and **[7]** keys to input the ending status byte "F7".
12. Confirm what's indicated, and press the **[ENTER]** button.
13. Specify the output port. (→**Specifying the port** (p. 62))
14. If you are making an assignment for a button, specify the button mode. (→**Specifying the button mode** (p. 62))

The GM2 System On message has now been assigned.

Master Volume

F0 7F 7F 04 01 vL vM F7

Since a Master Volume message has a data range of 00 00–7F 7F and we do not need to specify the range, we will use **Basic mode**. Since the two bytes of data are in the order of LSB and then MSB, we will select “DT3” (p. 80) when we input the data.

1. Press the **[EDIT]** button.
The display will indicate “EDT”.
2. Slightly move the controller to which you want to assign the system exclusive message. In the case of a button, press that button.
The display will indicate the number of the selected controller.
3. Confirm what’s indicated, and press the **[ENTER]** button.
4. Press an **ASSIGNABLE FUNCTION** key (◀▶) on the keyboard enough times to get “SE0” to appear in the display.
5. Confirm what’s indicated, and press the **[ENTER]** button.
The display will indicate “F0,” which is the first byte (beginning status) of a system exclusive message. (This cannot be changed.)
6. Confirm what’s indicated, and press the **[ENTER]** button.
7. Use the **[7]** and **[F]** keys to input the second byte “7F”.
8. Confirm what’s indicated, and press the **[ENTER]** button.
Input the third, fourth and fifth bytes in the same way.
9. Since the sixth byte is the data area, press the **[DATA]** key, and then press **[3]**.
The display will indicate “DT3”.
10. Confirm what’s indicated, and press the **[ENTER]** button.
11. Since we selected “DT3” as the sixth byte, the seventh byte will automatically be allocated as the data area and cannot be modified.
12. Confirm what’s indicated, and press the **[ENTER]** button.
13. Use the **[F]** and **[7]** keys to input the ending status byte “F7”.
14. Confirm what’s indicated, and press the **[ENTER]** button.
15. Specify the output port. (→ **Specifying the port** (p. 62))
16. If you are making an assignment for a button, specify the button mode. (→ **Specifying the button mode** (p. 62))

The Master Volume message has now been assigned.

Bend Pitch Control

Since the GS Bend Pitch Control message has a data range of 40H–58H (0–24 semitones), we will select **Advanced mode 1**, which lets us specify the range. Since the data format is one byte, we will select “DT0” (p. 80) when inserting the data.

1. Press the **[EDIT]** button.
The display will indicate “EDT”.
2. Slightly move the controller to which you want to assign the system exclusive message. In the case of a button, press that button.
The display will indicate the number of the selected controller.
3. Confirm what’s indicated and press **[ENTER]**.
4. Using the **ASSIGNABLE FUNCTION** keys (◀▶) on the keyboard, get “SE0” to appear in the display, then press the **[1]** key of the keyboard.
The display will indicate “SE1”.
5. Confirm what’s indicated and press **[ENTER]**.
The display will blink “F0”, which is the first byte (beginning status) of a system exclusive message. (This cannot be changed.)
6. Confirm what’s indicated and press **[ENTER]**.
7. Use the **[4]** and **[1]** keys to input the second byte “41”.
8. Confirm what’s indicated and press **[ENTER]**.
Input the third, fourth and fifth bytes in the same way.
9. Since the sixth byte is the beginning of the checksum calculation area, press the **[CHECKSUM]** key to specify this byte as the beginning of the area for which the checksum will be calculated.
10. Confirm what’s indicated and press **[ENTER]**.
11. Input the sixth byte.
12. Since the seventh byte will have “2” in the upper bits and the block number in the lower bits, press **[DATA]** three times.
The display will indicate “0BL”.
13. To specify “2” for the upper bits, press the **[2]** key.
The display will indicate “2BL”.
14. Confirm what’s indicated and press **[ENTER]**.
15. In the same way, enter bytes 8.
16. Since the ninth byte is the data area, press the **[DATA]** key.
The display will indicate “DT0.”
17. Confirm what’s indicated and press **[ENTER]**.
18. Since the tenth byte will contain the checksum, press the **[CHECKSUM]** key to specify the location at which the checksum will be input.
The display will blink “CS1” (Checksum Type 1).
19. Confirm what’s indicated and press **[ENTER]**.
20. Press the **[F]** and then **[7]** keys to input the ending status “F7.”
21. Confirm what’s indicated and press **[ENTER]**.
22. Next, specify an upper limit value of “58” for the data area.
23. Press **[ENTER]**.
24. Specify a lower limit value of “40” for the data area.
25. Press **[ENTER]**.
26. Specify the output port.
(→ **Specifying the port** (p. 62))
27. If you are making an assignment for a button, specify the button mode.
(→ **Specifying the button mode** (p. 62))

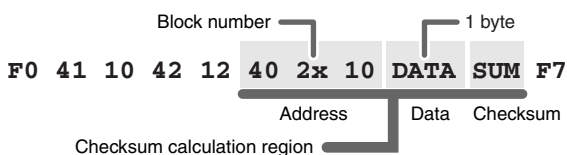

The GS Bend Pitch Control message has been assigned.

■ TEMPO ASSIGN

You can assign a controller to adjust the speed (20–250) of the F8 Clock message.

* *In order to transmit F8 Clock messages, the F8 CLOCK setting must be "ON".*

(→"F8 CLOCK ON/OFF" (p. 94))

1

Press the **[EDIT]** button.

The display will indicate "EDT."

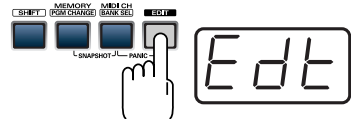

2

Slightly move the controller to which you want to assign TEMPO. In the case of a button, press that button.

The display will indicate the number of the selected controller.

3

Confirm what's indicated and press the **[ENTER]** button.



4

Press an **ASSIGNABLE FUNCTION** key (◀▶) on the keyboard enough times to get "TMP" to appear in the display.

5

Confirm what's indicated and press the **[ENTER]** button.



6

If you are making the assignment for a button, specify the button mode.

(→**Specifying the button mode** (p. 62))

In the case of a button, the value will be fixed at maximum (250) for ON, and minimum (20) for OFF.

Copying a MIDI message assignment (ASSIGN COPY)

Here's how a message assigned to a controller can be copied to another controller.

1

Press the **[EDIT]** button.

The display will indicate "EDT".

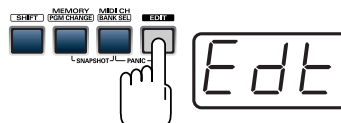

2

Slightly move the controller to which you want to copy the assignment (the "copy destination"). In the case of a button, press that button.

The display will indicate the number of the selected controller.

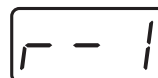

3

Confirm what's indicated and press the **[ENTER]** button.

4

Slightly move the controller whose assignment you want to copy (the "copy source"). In the case of a button, press that button.

The display will indicate "CPY".



5

Press the **[ENTER]** button.

The display will blink the copy-source controller number.

6

Confirm what's indicated and press the **[ENTER]** button.

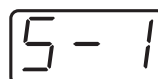

Canceling a MIDI message assignment (NO ASSIGN)

Here's how you can cancel the message assigned to a controller. Once its assignment is cancelled, no message will be transmitted when you operate that particular controller.

1

Press the **[EDIT]** button.

The display will indicate "EDT".

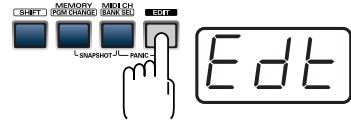

2

Slightly move the controller whose assignment you want to cancel. In the case of a button, press that button.

The display will indicate the number of the selected controller.



3

Confirm what's indicated and press the **[ENTER]** button.

4

Press an **ASSIGNABLE FUNCTION** key (◀▶) on the keyboard enough times to get "NOA" to appear in the display.



5

Press the **[ENTER]** button.

6

The display will blink "YES," so press the **[ENTER]** button once again.

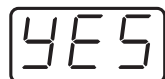

Saving a memory set (SAVE)

Here's how to save the settings of the **current memory** into internal memory.

You can save settings into internal memory numbers 1–F.

You cannot save to memory number 0 (GM2).

* After you edit the settings, perform the "SAVE" operation as needed. If you turn off the power without performing "SAVE", your changes will be lost.

1

Press the **[EDIT]** button.

The display will indicate "EDT".

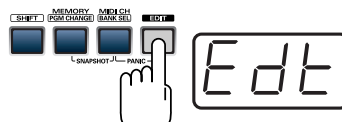

2

Press the **[SAVE]** key.

The display will blink "SAV."



3

Confirm what's indicated and press the **[ENTER]** button.

If the display indicates "PTC", it means that the Save could not be carried out because the PROTECT setting (p. 92) is on. Turn PROTECT off, and then try the operation once again from step 1.

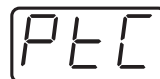

4

Select a memory number 1–F. Use the **[DEC]** **[INC]** buttons or the **[1]** – **[F]** keys to specify the save-destination memory number.

The specified memory number will blink in the display.

5

Confirm what's indicated and press the **[ENTER]** button.

About the memories of the PCR

The PCR has the following sixteen memories.

Memory number 0	GM2 SET	Cannot be saved
Memory number 1 :	User memories (15)	Can be saved
Memory number F		

"**Current memory**" is a location into which you can recall one of these memories.

In order to use one of the saved memories, you must recall it into current memory as described in **Memory mode (MEMORY)** (p. 59).

The contents of current memory will be lost when you turn off the power. If you have modified the settings in current memory, perform the "SAVE" operation if you want to keep your changes.

You can set the **STARTUP MEMORY** (p. 95) setting to specify the memory that will be loaded into current memory when you turn on the power.

Transmitting/receiving bulk data (BULK)

Bulk dump allows a large amount of data to be transferred in a single operation. For example, this can be used to store all settings of a device into a computer or sequencer.

* When you transmit or receive Bulk data, the contents of the **current memory** will be lost. Save the current memory settings as needed before you perform this operation.

Receive mode

1

Press the **[EDIT]** button.

The display will indicate "EDT".

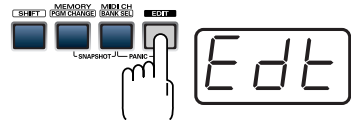

2

Press the **[BULK]** key.

The display will blink "BLR" (Bulk Receive).

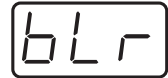

3

Confirm what's indicated and press the **[ENTER]** button.

The display will indicate "RS", and the "S" will blink.

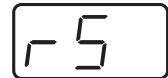

4

Use the **[DEC]** **[INC]** buttons or the **[0]** **[1]** keys to select the mode.

0		SINGLE BULK	The received data will overwrite the current memory. Memories 1-F will not be affected.
1		ALL BULK	The received data will overwrite memories 1-F.

5

Confirm what's indicated and press the **[ENTER]** button.

The third digit of the display will blink, and the PCR-1 will wait to receive bulk data.

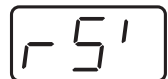

About the display in Bulk mode

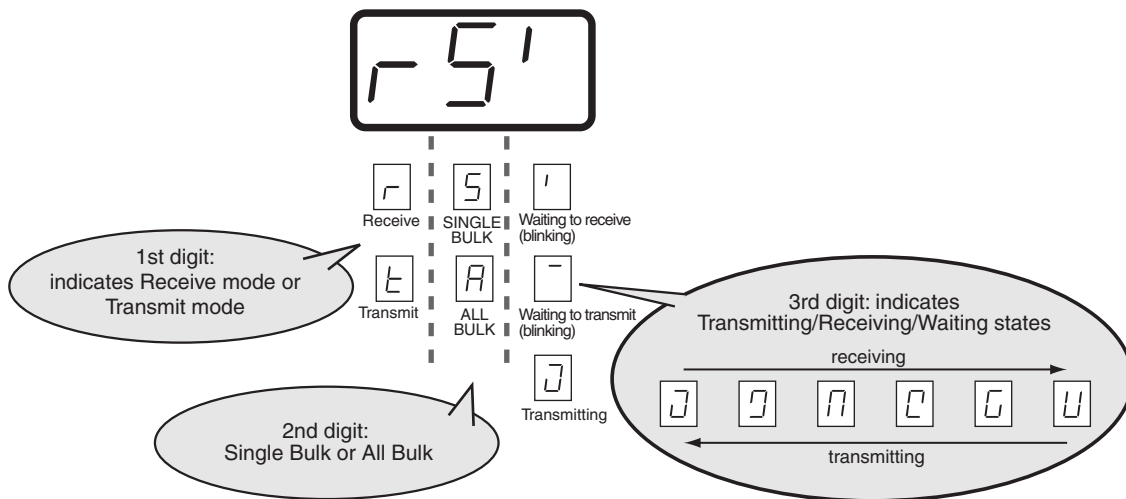

6

Transmit bulk data from your sequencer or other device.

Specify "PCR" (Mac OS 9: PCR-1 1) as the MIDI output device for your sequencer software. For details on this setting, refer to the manual of your sequencer software.

For details on the port that will be used to transfer bulk data, refer to **Input / output devices** (p. 44).

7

When the PCR finishes receiving the bulk data, the display will indicate "END".

End

Error display

Errr

If the data could not be received correctly, the display will blink "ERR".

If this occurs, press the **[CANCEL]** button to cancel the "ERR" display.

Once "ERR" has been dismissed, perform the bulk reception procedure over again, from step 1.

8

Confirm what's indicated and press the **[ENTER]** button.

Transmit mode

- 1** Press the **[EDIT]** button.
The display will indicate “EDT”.

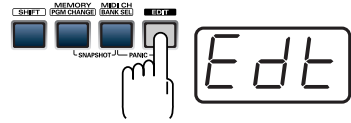

- 2** Press the **[BULK]** key.

- 3** Press the **[1]** key.
The display will blink “BLT” (Bulk Transmit).

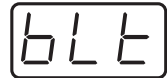

- 4** Confirm what's indicated and press the **[ENTER]** button.
The display will indicate “TS”, and the “S” will blink.



- 5** Use the **[DEC]** **[INC]** buttons or the **[0]** **[1]** keys to select the mode.

0		SINGLE BULK	The currently recalled memory (the current memory) will be transmitted as bulk data
1		ALL BULK	All memories (memories 1–F) will be transmitted as bulk data.

- 6** Confirm what's indicated and press the **[ENTER]** button.

- 7** The third digit of the display will blink, and the PCR-1 will wait to transmit bulk data.

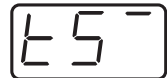

- 8** Press the **[ENTER]** button.

On your sequencer software, specify “PCR -1 2” as the MIDI input device. For details on this setting, refer to the manual of your sequencer software.

For details on the port that will be used to transfer bulk data, refer to **Input / output devices** (p. 44).

- 9** When the PCR finishes receiving the bulk data, the display will indicate “END”.



- 10** Confirm what's indicated and press the **[ENTER]** button.

Protecting a memory set (PROTECT)

If you turn the Protect setting ON, **ALL BULK** (p. 89) reception and **SAVE** (p. 88) operations will be disabled.

1

Press the **[EDIT]** button.

The display will indicate "EDT".

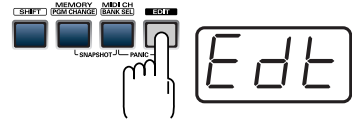

2

Press the **[PROTECT]** key.

The display will blink "PTC".

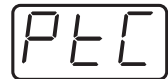

3

Confirm what's indicated and press the **[ENTER]** button.

4

The display will show the current setting.

0		PROTECT OFF	Allow changes.
1		PROTECT ON	Prohibit changes.

5

Use the **[DEC]** **[INC]** buttons or the **[0]** **[1]** keys to select the mode.

6

Press the **[ENTER]** button.

System settings

Here's how you can make various system settings for the PCR-1.

1

Press the **[EDIT]** button.
The display will indicate "EDT".

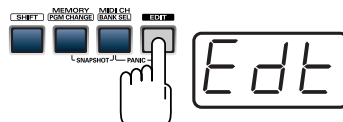

2

Press the **[SYSTEM]** key.
The display will indicate "SY0".

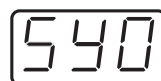

3

Use the **[0] - [8]**, **[A] - [E]** keys to specify the System setting that you want to set, and then press the **[ENTER]** button.
Confirm what's indicated and use the appropriate method to make the setting.

Mode	Key-board	Content of the setting	Default	Setting method
F8 CLOCK ON/OFF	0	Specify whether F8 Clock is to be transmitted.	OFF	p. 94
F8 CLOCK DEFAULT TEMPO	1	If "F8 CLOCK ON/OFF" is ON, specify the default value of the F8 Clock. After the power is turned on, this tempo will continue to be output until you move a controller to which TEMPO is assigned.	120	p. 94
F8 CLOCK PORT SET	2	If "F8 CLOCK ON / OFF" is ON, specify the port from which the F8 Clock is to be transmitted.	PORT 1	p. 94
VELOCITY OFFSET	3	The value you specify here will be added to the velocity of the notes played from the keyboard. <i>* If the result of the addition would exceed 7FH, the velocity will be 7FH.</i>	0	p. 94
KEYBOARD PORT SET	4	Specify the port from which messages produced by the BENDER lever of the keyboard are to be transmitted.	PORT 1	p. 94
H-ACTIVITY ON / OFF	5	Turn this ON if you are using certain applications (such as Pro Tools LE). When ON, "90 00 7F" will be output from PCR 2 approximately every 500 ms.	OFF	p. 95
USB MIDI DRIVER MODE	6	Specify the type of USB MIDI driver used for USB connection. <i>* The setting will take effect the next time you turn on the power</i>	Original Driver	p. 95
STARTUP MEMORY	7	Specify the memory that will be selected when the power is turned on.	GM2	p. 95
FACTORY RESET	8	Restore all settings of the PCR-1 to their factory-set condition.	-	p. 95
USB AUDIO ON / OFF	A	Switch the USB AUDIO functionality ON / OFF. <i>The setting will take effect the next time you turn on the power</i>	ON	p. 96
USB AUDIO MODE SETTING	B	Specify the USB AUDIO sampling frequency and driver mode. <i>* The setting will take effect the next time you turn on the power</i>	44.1kHz (ADVANCE)	p. 96
DIRECT MONITOR ON / OFF	C	Make Direct Monitor settings (Sending the input signal from the audio input jacks directly to the PCR-1's headphone jack).	ON	p. 97
PITCH BEND TIME	D	Specify the time it is to take for the maximum pitch bend to be reached after you press the bender switch. Higher settings for this value produce a slower pitch bend.	2	p. 97
MODULATION SETTING	E	Specify the value of the Modulation message (CC#01) transmitted when you press the Modulation Button .	127	p. 97

F8 CLOCK ON / OFF (Keyboard : 0)

Perform steps 1-3.

4. Use the **[DEC]** **[INC]** buttons or the **[0]** or **[1]** keys to switch F8 CLOCK ON / OFF.

0	OFF
1	ON

The display will indicate either "ON" or "OFF".

5. Press the **[ENTER]** button.

F8 CLOCK DEFAULT TEMPO (Keyboard : 1)

Perform steps 1-3.

4. Use the **[DEC]** **[INC]** buttons or the **[0]** - **[F]** keys to specify F8 CLOCK DEFAULT TEMPO. (Value range 20-250)

The specified value will indicate in the display.

5. Press the **[ENTER]** button.

F8 CLOCK PORT SET (Keyboard : 2)

Perform steps 1-3.

4. Use the **[DEC]** **[INC]** buttons or the **[1]** - **[3]** keys to specify F8 CLOCK PORT SET .
(→**Specifying the port** (p. 62))

The specified port will indicate in the display.

5. Press the **[ENTER]** button.

VELOCITY OFFSET (Keyboard : 3)

Perform steps 1-3.

4. Use the **[DEC]** **[INC]** buttons or the **[0]** - **[F]** keys to specify VELOCITY OFFSET.
(Value range 0-127)

The specified value will indicate in the display.

5. Press the **[ENTER]** button.

KEYBOARD PORT SET (Keyboard : 4)

Perform steps 1-3.

4. Use the **[DEC]** **[INC]** buttons or the **[1]** - **[3]** keys to specify KEYBOARD PORT SET.
(→**Specifying the port** (p. 62))

The specified port will indicate in the display.

5. Press the **[ENTER]** button.

H-ACTIVITY ON / OFF (Keyboard : 5)

Perform steps 1-3.

0	OFF
1	ON

4. Use the [DEC] [INC] buttons or the [0] or [1] keys to switch H-ACTIVITY ON / OFF.



The display will indicate either "ON" or "OFF".

5. Press the [ENTER] button.

USB MIDI DRIVER MODE (Keyboard : 6)

Perform steps 1-3.

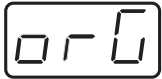
4. Use the [DEC] [INC] buttons or the [0] or [1] keys to specify the USB MIDI DRIVER MODE.

0		Original driver	FPT technology is used to perform high-speed MIDI transfer. Normally, we recommend that you use this mode.
1		Generic driver	Select this if you are using the standard MIDI driver provided by your operating system.

* **FPT = Fast Processing Technology for MIDI Transmission:**



Effective use is made of the USB bandwidth according to the amount of MIDI data to be transmitted, ensuring that MIDI data processing will always occur optimally.

5. Press the [ENTER] button.

STARTUP MEMORY (Keyboard : 7)

Perform steps 1-3.

4. Use the [DEC] [INC] buttons or the [0] or [1] keys to specify the GM2/LAST ACCESS MEMORY setting.

0		GM2 MEMORY	When the PCR starts up, memory number 0 (GM2) will be loaded into current memory (p. 88) regardless of the state in which the power was turned off.
1		LAST ACCESS MEMORY	Upon power-up, the PCR-1 will recall the memory that was last recalled or saved into current memory (p. 88).

5. Press the [ENTER] button.

FACTORY RESET (Keyboard : 8)

Perform steps 1-3.

4. The display will indicate "RST".

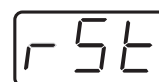

5. Press the [ENTER] button.
The display will blink "YES".



6. Press the [ENTER] button.

USB AUDIO ON / OFF (Keyboard : A)

The USB AUDIO ON/OFF setting will take effect when you reconnect the USB cable.
Perform steps 1–3.

4. Use the [DEC] [INC] buttons or the [0] or [1] keys to switch USB AUDIO ON / OFF.

0	OFF
1	ON







The display will indicate either “ON” or “OFF”.

5. Press the [ENTER] button.

USB AUDIO MODE SETTING (Keyboard : B)

The USB AUDIO ON/OFF setting will take effect when you reconnect the USB cable.
Perform steps 1–3.

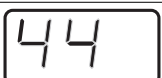
4. Use the [DEC] [INC] buttons or the [0] - [5] keys to switch USB AUDIO SAMPLING FREQUENCY or DRIVER MODE.



0		44.1kHz (ADVANCE)	Advanced mode The special driver will be used, allowing audio to be recorded/played with high quality and stable timing. In Advanced mode, audio signals can be transferred between the PCR-1 and the computer at a resolution of 24 bits and sampling frequencies of 44.1 / 48 / 96 kHz . Select this mode if you are using an application that allows high-quality audio recording/playback, such as an application that supports 24 bit audio or an ASIO-compatible application. We recommend that you normally use this mode.
1		48kHz (ADVANCE)	
2		96kHz PLAY (ADVANCE)	
3		96kHz REC (ADVANCE)	Standard driver mode The standard driver provided by the operating system will be used. Audio data will be transferred between the PCR-1 and your computer with 16-bit depth and a sampling frequency of 44.1/48 kHz . Use this setting if you are using the Mac OS 9 sound manager.
4		44.1kHz	
5		48kHz	

5. Press the [ENTER] button.

DIRECT MONITOR ON / OFF (Keyboard : C)

Perform steps 1-3.

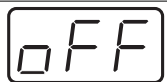
- Use the [DEC] [INC] buttons or the [0] - [2] keys to switch DIRECT MONITOR ON / OFF.

0		OFF	The input signal from the audio input jacks will not be sent to the headphone jack, or master output jacks.
1		AUTO	Settings or operations in your ASIO 2.0 application (e.g., Cubase) will switch Direct Monitor ON / OFF.
2		ON	The input signal from the audio input jacks will be output to the PCR-1's speakers, headphone jack, and master output jacks.

- Press the [ENTER] button.

PITCH BEND TIME (Keyboard : D)

Perform steps 1-3.

- Use the [DEC] [INC] buttons or the [0] - [5] keys to specify PITCH BEND TIME . (Value range 0-5)
The specified value will indicate in the display.
- Press the [ENTER] button.

MODULATION SETTING (Keyboard : E)

Perform steps 1-3.

- Use the [DEC] [INC] buttons or the [0] - [F] keys to specify MODULATION SETTING.
(Value range 0-127)
The specified value will indicate in the display.
- Press the [ENTER] button.

MEMO

Appendices

This section contains troubleshooting information and explanations of convenient functions. You may read this material as necessary.

Memory sets	p. 100
Troubleshooting	p. 106
MIDI implementation	p. 117
Main specifications	p. 122

Memory sets

With the factory settings, the GM2 set shown in the illustration is assigned to the controllers.

Use the included template.

The following memory sets are also provided.

GM2 set (MEMORY: 0) (p. 100)	H-COMPATIBLE (ProTools LE, Digital Performer 3)
MCR-8 MODE 3 (SONAR 2) SET (p. 101)	SET (MEMORY: 9) (p. 103)
MCR-8 MODE 3 (SONAR 2) - A (MEMORY: 1).... (p. 101)	GS SET (p. 103)
MCR-8 MODE 3 (SONAR 2) - B (MEMORY: 2) (p. 101)	GS-A (MEMORY: A) (p. 103)
MCR-8 MODE 3 (SONAR 2) - C (MEMORY: 3).... (p. 101)	GS-B (MEMORY: B)..... (p. 104)
MCR-8 MODE 3 (SONAR 2) - D (MEMORY: 4).... (p. 101)	GS-C (MEMORY: C)..... (p. 104)
MCR-8 MODE 4 (Cubase 5/SX) SET (p. 102)	XG SET (p. 105)
MCR-8 MODE 4 (Cubase 5/SX) - A (MEMORY: 5)(p. 102)	XG-A (MEMORY: D)..... (p. 105)
MCR-8 MODE 4 (Cubase 5/SX) - B (MEMORY: 6)(p. 102)	XG-B (MEMORY: E) (p. 105)
MCR-8 MODE 4 (Cubase 5/SX) - C (MEMORY: 7))(p. 102)	
MCR-8 MODE 4 (Cubase 5/SX) - D (MEMORY: 8)(p. 102)	

For details on settings for actually using each memory set with your application, refer to the Read Me file for each memory set, located in the Memory Files folder of the CD-ROM.

Since the PCR-1 does not have controllers [P1] and [P2], the PCR-1 itself is unable to transmit or edit the messages assigned to these controllers.

(Internally, the PCR-1 does maintain data for [P1] and [P2].)

In order to maintain memory set compatibility with other models in the PCR series, all memory sets include the data for [P1] and [P2] when they are bulk-dumped.

■ GM2 set (MEMORY: 0)

	Parameter	Message (Hex.)	Range (Hex.)	Ch.	Port
R1	FILTER CUTOFF	CC 74(4A)	0(00) - 127(7F)	1	1
R2	FILTER RESONANCE	CC 71(47)	0(00) - 127(7F)	1	1
R3	VIBRATO RATE	CC 76(4C)	0(00) - 127(7F)	1	1
R4	VIBRATO DEPTH	CC 77(4D)	0(00) - 127(7F)	1	1
R5	VIBRATO DELAY	CC 78(4E)	0(00) - 127(7F)	1	1
R6	COARSE TUNING	RPN 0/2(00/02)	0/- (00/-) - 127/- (7F/-)	1	1
R7	FINE TUNING	RPN 0/1(00/01)	0/0(00/00) - 127/127(7F/7F)	1	1
R8	PAN (CHANNEL)	CC 10(0A)	0(00) - 127(7F)	1	1
S1	PORTAMENTO TIME	CC 5(05)	0(00) - 127(7F)	1	1
S2	AFTERTOUCH	CHANNEL PRESSURE	0(00) - 127(7F)	1	1
S3	ENVELOPE ATTACK	CC 73(49)	0(00) - 127(7F)	1	1
S4	ENVELOPE DECAY	CC 75(4B)	0(00) - 127(7F)	1	1
S5	ENVELOPE RELEASE	CC 72(48)	0(00) - 127(7F)	1	1
S6	CHORUS	CC 93(5D)	0(00) - 127(7F)	1	1
S7	REVERB	CC 91(5B)	0(00) - 127(7F)	1	1
S8	VOLUME (CHANNEL)	CC 7(07)	0(00) - 127(7F)	1	1
B1	PROGRAM CHANGE DEC	PROGRAM CHANGE	min:1(00)	-	-
B2	PROGRAM CHANGE INC	PROGRAM CHANGE	max:128(7F)	-	-
B3	PORTAMENTO ON/OFF	CC 65(41)	0(00) / 127(7F)	1	1
B4	POLY MODE ON	B0 7F 00	-	1	1
B5	MONO MODE ON	B0 7E 01	-	1	1
B6	GM2 SYSTEM ON	F0 7E 7F 09 03 F7	-	-	1
L1	STOP	FC	-	-	2
L2	START	FA	-	-	2
L3	CONTINUE	FB	-	-	2
P1	HOLD	CC 64(40)	0(00) / 127(7F)	1	1
P2	EXPRESSION	CC 11(0B)	0(00) - 127(7F)	1	1

■ MCR-8 MODE 3 (SONAR 2) SET

When using this memory set, turn the PCR-1's OMNI (p. 54) setting OFF.

MCR-8 MODE 3 (SONAR 2) - A (MEMORY: 1)

	Parameter	Message (Hex.)	Range (Hex.)	Ch.	Port
R1	TRACK 1	*1 CC 16(10)	0(00) - 127(7F)	1	2
R2	TRACK 2	*1 CC 16(10)	0(00) - 127(7F)	2	2
R3	TRACK 3	*1 CC 16(10)	0(00) - 127(7F)	3	2
R4	TRACK 4	*1 CC 16(10)	0(00) - 127(7F)	4	2
R5	TRACK 5	*1 CC 16(10)	0(00) - 127(7F)	5	2
R6	TRACK 6	*1 CC 16(10)	0(00) - 127(7F)	6	2
R7	TRACK 7	*1 CC 16(10)	0(00) - 127(7F)	7	2
R8	TRACK 8	*1 CC 16(10)	0(00) - 127(7F)	8	2
S1	TRACK 1	*2 CC 17(11)	0(00) - 127(7F)	1	2
S2	TRACK 2	*2 CC 17(11)	0(00) - 127(7F)	2	2
S3	TRACK 3	*2 CC 17(11)	0(00) - 127(7F)	3	2
S4	TRACK 4	*2 CC 17(11)	0(00) - 127(7F)	4	2
S5	TRACK 5	*2 CC 17(11)	0(00) - 127(7F)	5	2
S6	TRACK 6	*2 CC 17(11)	0(00) - 127(7F)	6	2
S7	TRACK 7	*2 CC 17(11)	0(00) - 127(7F)	7	2
S8	TRACK 8	*2 CC 17(11)	0(00) - 127(7F)	8	2
B1	TRACK 1	*3 CC 80(50)	0(00) / 127(7F)	1	2
B2	TRACK 2	*3 CC 80(50)	0(00) / 127(7F)	2	2
B3	TRACK 3	*3 CC 80(50)	0(00) / 127(7F)	3	2
B4	TRACK 4	*3 CC 80(50)	0(00) / 127(7F)	4	2
B5	TRACK 5	*3 CC 80(50)	0(00) / 127(7F)	5	2
B6	TRACK 6	*3 CC 80(50)	0(00) / 127(7F)	6	2
L1	<<	CC 82(52)	0(00) / 127(7F)	13	2
L2	■ Stop	CC 82(52)	0(00) / 127(7F)	14	2
L3	> Play	CC 82(52)	0(00) / 127(7F)	15	2
P1	HOLD	CC 64(40)	0(00) / 127(7F)	1	1
P2	EXPRESSION	CC 11(0B)	0(00) - 127(7F)	1	1

MCR-8 MODE 3 (SONAR 2) - B (MEMORY: 2)

	Parameter	Message (Hex.)	Range (Hex.)	Ch.	Port
R1	TRACK 1	*1 CC 16(10)	0(00) - 127(7F)	1	2
R2	TRACK 2	*1 CC 16(10)	0(00) - 127(7F)	2	2
R3	TRACK 3	*1 CC 16(10)	0(00) - 127(7F)	3	2
R4	TRACK 4	*1 CC 16(10)	0(00) - 127(7F)	4	2
R5	TRACK 5	*1 CC 16(10)	0(00) - 127(7F)	5	2
R6	TRACK 6	*1 CC 16(10)	0(00) - 127(7F)	6	2
R7	TRACK 7	*1 CC 16(10)	0(00) - 127(7F)	7	2
R8	TRACK 8	*1 CC 16(10)	0(00) - 127(7F)	8	2
S1	TRACK 1	*2 CC 17(11)	0(00) - 127(7F)	1	2
S2	TRACK 2	*2 CC 17(11)	0(00) - 127(7F)	2	2
S3	TRACK 3	*2 CC 17(11)	0(00) - 127(7F)	3	2
S4	TRACK 4	*2 CC 17(11)	0(00) - 127(7F)	4	2
S5	TRACK 5	*2 CC 17(11)	0(00) - 127(7F)	5	2
S6	TRACK 6	*2 CC 17(11)	0(00) - 127(7F)	6	2
S7	TRACK 7	*2 CC 17(11)	0(00) - 127(7F)	7	2
S8	TRACK 8	*2 CC 17(11)	0(00) - 127(7F)	8	2
B1	TRACK 1	*4 CC 81(51)	0(00) / 127(7F)	1	2
B2	TRACK 2	*4 CC 81(51)	0(00) / 127(7F)	2	2
B3	TRACK 3	*4 CC 81(51)	0(00) / 127(7F)	3	2
B4	TRACK 4	*4 CC 81(51)	0(00) / 127(7F)	4	2
B5	TRACK 5	*4 CC 81(51)	0(00) / 127(7F)	5	2
B6	TRACK 6	*4 CC 81(51)	0(00) / 127(7F)	6	2
L1	<<	CC 82(52)	0(00) / 127(7F)	13	2
L2	■ Stop	CC 82(52)	0(00) / 127(7F)	14	2
L3	> Play	CC 82(52)	0(00) / 127(7F)	15	2
P1	HOLD	CC 64(40)	0(00) / 127(7F)	1	1
P2	EXPRESSION	CC 11(0B)	0(00) - 127(7F)	1	1

MCR-8 MODE 3 (SONAR 2) - C (MEMORY: 3)

	Parameter	Message (Hex.)	Range (Hex.)	Ch.	Port
R1	TRACK 9	*1 CC 16(10)	0(00) - 127(7F)	9	2
R2	TRACK 10	*1 CC 16(10)	0(00) - 127(7F)	10	2
R3	TRACK 11	*1 CC 16(10)	0(00) - 127(7F)	11	2
R4	TRACK 12	*1 CC 16(10)	0(00) - 127(7F)	12	2
R5	TRACK 13	*1 CC 16(10)	0(00) - 127(7F)	13	2
R6	TRACK 14	*1 CC 16(10)	0(00) - 127(7F)	14	2
R7	TRACK 15	*1 CC 16(10)	0(00) - 127(7F)	15	2
R8	TRACK 16	*1 CC 16(10)	0(00) - 127(7F)	16	2
S1	TRACK 9	*2 CC 17(11)	0(00) - 127(7F)	9	2
S2	TRACK 10	*2 CC 17(11)	0(00) - 127(7F)	10	2
S3	TRACK 11	*2 CC 17(11)	0(00) - 127(7F)	11	2
S4	TRACK 12	*2 CC 17(11)	0(00) - 127(7F)	12	2
S5	TRACK 13	*2 CC 17(11)	0(00) - 127(7F)	13	2
S6	TRACK 14	*2 CC 17(11)	0(00) - 127(7F)	14	2
S7	TRACK 15	*2 CC 17(11)	0(00) - 127(7F)	15	2
S8	TRACK 16	*2 CC 17(11)	0(00) - 127(7F)	16	2
B1	TRACK 9	*3 CC 80(50)	0(00) / 127(7F)	9	2
B2	TRACK 10	*3 CC 80(50)	0(00) / 127(7F)	10	2
B3	TRACK 11	*3 CC 80(50)	0(00) / 127(7F)	11	2
B4	TRACK 12	*3 CC 80(50)	0(00) / 127(7F)	12	2
B5	TRACK 13	*3 CC 80(50)	0(00) / 127(7F)	13	2
B6	TRACK 14	*3 CC 80(50)	0(00) / 127(7F)	14	2
L1	Automation Write	CC 82(52)	0(00) / 127(7F)	12	2
L2	■ Stop	CC 82(52)	0(00) / 127(7F)	14	2
L3	Rec	CC 82(52)	0(00) / 127(7F)	11	2
P1	HOLD	CC 64(40)	0(00) / 127(7F)	1	1
P2	EXPRESSION	CC 11(0B)	0(00) - 127(7F)	1	1

MCR-8 MODE 3 (SONAR 2) - D (MEMORY: 4)

	Parameter	Message (Hex.)	Range (Hex.)	Ch.	Port
R1	TRACK 9	*1 CC 16(10)	0(00) - 127(7F)	9	2
R2	TRACK 10	*1 CC 16(10)	0(00) - 127(7F)	10	2
R3	TRACK 11	*1 CC 16(10)	0(00) - 127(7F)	11	2
R4	TRACK 12	*1 CC 16(10)	0(00) - 127(7F)	12	2
R5	TRACK 13	*1 CC 16(10)	0(00) - 127(7F)	13	2
R6	TRACK 14	*1 CC 16(10)	0(00) - 127(7F)	14	2
R7	TRACK 15	*1 CC 16(10)	0(00) - 127(7F)	15	2
R8	TRACK 16	*1 CC 16(10)	0(00) - 127(7F)	16	2
S1	TRACK 9	*2 CC 17(11)	0(00) - 127(7F)	9	2
S2	TRACK 10	*2 CC 17(11)	0(00) - 127(7F)	10	2
S3	TRACK 11	*2 CC 17(11)	0(00) - 127(7F)	11	2
S4	TRACK 12	*2 CC 17(11)	0(00) - 127(7F)	12	2
S5	TRACK 13	*2 CC 17(11)	0(00) - 127(7F)	13	2
S6	TRACK 14	*2 CC 17(11)	0(00) - 127(7F)	14	2
S7	TRACK 15	*2 CC 17(11)	0(00) - 127(7F)	15	2
S8	TRACK 16	*2 CC 17(11)	0(00) - 127(7F)	16	2
B1	TRACK 9	*4 CC 81(51)	0(00) / 127(7F)	9	2
B2	TRACK 10	*4 CC 81(51)	0(00) / 127(7F)	10	2
B3	TRACK 11	*4 CC 81(51)	0(00) / 127(7F)	11	2
B4	TRACK 12	*4 CC 81(51)	0(00) / 127(7F)	12	2
B5	TRACK 13	*4 CC 81(51)	0(00) / 127(7F)	13	2
B6	TRACK 14	*4 CC 81(51)	0(00) / 127(7F)	14	2
L1	Automation Write	CC 82(52)	0(00) / 127(7F)	12	2
L2	■ Stop	CC 82(52)	0(00) / 127(7F)	14	2
L3	Rec	CC 82(52)	0(00) / 127(7F)	11	2
P1	HOLD	CC 64(40)	0(00) / 127(7F)	1	1
P2	EXPRESSION	CC 11(0B)	0(00) - 127(7F)	1	1

Generic Surface Preset	*1	*2	*3	*4
Roland MCR-8 (Aux Send 1)	Aux Send 1 Pan	Aux Send 1 Level	Aux Send 1 Pre/Post	Aux Send 1 Enable
Roland MCR-8 (Aux Send 2)	Aux Send 2 Pan	Aux Send 2 Level	Aux Send 2 Pre/Post	Aux Send 2 Enable
Roland MCR-8 (Mute + Solo)	Pan	Volume	Mute	Solo
Roland MCR-8 (Record Arming)	Pan	Volume	White Arm	Record Arm

■ MCR-8 MODE 4 (Cubase 5/SX) SET

When using this memory set, turn the PCR-1's OMNI (p. 54) setting OFF.

MCR-8 MODE 4 (Cubase 5/SX) - A (MEMORY: 5)

MCR-8 MODE 4 (Cubase 5/SX) - B (MEMORY: 6)

	Parameter	Message (Hex.)	Range (Hex.)	Ch.	Port
R1	TRACK 1 PAN	CC 72(48)	0(00) - 127(7F)	16	2
R2	TRACK 2 PAN	CC 73(49)	0(00) - 127(7F)	16	2
R3	TRACK 3 PAN	CC 74(4A)	0(00) - 127(7F)	16	2
R4	TRACK 4 PAN	CC 75(4B)	0(00) - 127(7F)	16	2
R5	TRACK 5 PAN	CC 76(4C)	0(00) - 127(7F)	16	2
R6	TRACK 6 PAN	CC 77(4D)	0(00) - 127(7F)	16	2
R7	TRACK 7 PAN	CC 78(4E)	0(00) - 127(7F)	16	2
R8	TRACK 8 PAN	CC 79(4F)	0(00) - 127(7F)	16	2
S1	TRACK 1 FADER	CC 64(40)	0(00) - 127(7F)	16	2
S2	TRACK 2 FADER	CC 65(41)	0(00) - 127(7F)	16	2
S3	TRACK 3 FADER	CC 66(42)	0(00) - 127(7F)	16	2
S4	TRACK 4 FADER	CC 67(43)	0(00) - 127(7F)	16	2
S5	TRACK 5 FADER	CC 68(44)	0(00) - 127(7F)	16	2
S6	TRACK 6 FADER	CC 69(45)	0(00) - 127(7F)	16	2
S7	TRACK 7 FADER	CC 70(46)	0(00) - 127(7F)	16	2
S8	TRACK 8 FADER	CC 71(47)	0(00) - 127(7F)	16	2
B1	TRACK 1 SOLO	CC 0(00)	0(00) / 127(7F)	16	2
B2	TRACK 2 SOLO	CC 1(01)	0(00) / 127(7F)	16	2
B3	TRACK 3 SOLO	CC 2(02)	0(00) / 127(7F)	16	2
B4	TRACK 4 SOLO	CC 3(03)	0(00) / 127(7F)	16	2
B5	TRACK 5 SOLO	CC 4(04)	0(00) / 127(7F)	16	2
B6	TRACK 6 SOLO	CC 5(05)	0(00) / 127(7F)	16	2
L1	<<	CC 19(13)	0(00) / 127(7F)	16	2
L2	■ Stop	CC 21(15)	0(00) / 127(7F)	16	2
L3	> Play	CC 22(16)	0(00) / 127(7F)	16	2
P1	HOLD	CC 64(40)	0(00) / 127(7F)	1	1
P2	EXPRESSION	CC 11(0B)	0(00) - 127(7F)	1	1

	Parameter	Message (Hex.)	Range (Hex.)	Ch.	Port
R1	TRACK 1 PAN	CC 72(48)	0(00) - 127(7F)	16	2
R2	TRACK 2 PAN	CC 73(49)	0(00) - 127(7F)	16	2
R3	TRACK 3 PAN	CC 74(4A)	0(00) - 127(7F)	16	2
R4	TRACK 4 PAN	CC 75(4B)	0(00) - 127(7F)	16	2
R5	TRACK 5 PAN	CC 76(4C)	0(00) - 127(7F)	16	2
R6	TRACK 6 PAN	CC 77(4D)	0(00) - 127(7F)	16	2
R7	TRACK 7 PAN	CC 78(4E)	0(00) - 127(7F)	16	2
R8	TRACK 8 PAN	CC 79(4F)	0(00) - 127(7F)	16	2
S1	TRACK 1 FADER	CC 64(40)	0(00) - 127(7F)	16	2
S2	TRACK 2 FADER	CC 65(41)	0(00) - 127(7F)	16	2
S3	TRACK 3 FADER	CC 66(42)	0(00) - 127(7F)	16	2
S4	TRACK 4 FADER	CC 67(43)	0(00) - 127(7F)	16	2
S5	TRACK 5 FADER	CC 68(44)	0(00) - 127(7F)	16	2
S6	TRACK 6 FADER	CC 69(45)	0(00) - 127(7F)	16	2
S7	TRACK 7 FADER	CC 70(46)	0(00) - 127(7F)	16	2
S8	TRACK 8 FADER	CC 71(47)	0(00) - 127(7F)	16	2
B1	TRACK 1 MUTE	CC 40(28)	0(00) / 127(7F)	16	2
B2	TRACK 2 MUTE	CC 41(29)	0(00) / 127(7F)	16	2
B3	TRACK 3 MUTE	CC 42(2A)	0(00) / 127(7F)	16	2
B4	TRACK 4 MUTE	CC 43(2B)	0(00) / 127(7F)	16	2
B5	TRACK 5 MUTE	CC 44(2C)	0(00) / 127(7F)	16	2
B6	TRACK 6 MUTE	CC 45(2D)	0(00) / 127(7F)	16	2
L1	<<	CC 19(13)	0(00) / 127(7F)	16	2
L2	■ Stop	CC 21(15)	0(00) / 127(7F)	16	2
L3	> Play	CC 22(16)	0(00) / 127(7F)	16	2
P1	HOLD	CC 64(40)	0(00) / 127(7F)	1	1
P2	EXPRESSION	CC 11(0B)	0(00) - 127(7F)	1	1

MCR-8 MODE 4 (Cubase 5/SX) - C (MEMORY: 7)

MCR-8 MODE 4 (Cubase 5/SX) - D (MEMORY: 8)

	Parameter	Message (Hex.)	Range (Hex.)	Ch.	Port
R1	TRACK 9 PAN	CC 56(38)	0(00) - 127(7F)	16	2
R2	TRACK 10 PAN	CC 57(39)	0(00) - 127(7F)	16	2
R3	TRACK 11 PAN	CC 58(3A)	0(00) - 127(7F)	16	2
R4	TRACK 12 PAN	CC 59(3B)	0(00) - 127(7F)	16	2
R5	TRACK 13 PAN	CC 60(3C)	0(00) - 127(7F)	16	2
R6	TRACK 14 PAN	CC 61(3D)	0(00) - 127(7F)	16	2
R7	TRACK 15 PAN	CC 62(3E)	0(00) - 127(7F)	16	2
R8	TRACK 16 PAN	CC 63(3F)	0(00) - 127(7F)	16	2
S1	TRACK 9 FADER	CC 48(30)	0(00) - 127(7F)	16	2
S2	TRACK 10 FADER	CC 49(31)	0(00) - 127(7F)	16	2
S3	TRACK 11 FADER	CC 50(32)	0(00) - 127(7F)	16	2
S4	TRACK 12 FADER	CC 51(33)	0(00) - 127(7F)	16	2
S5	TRACK 13 FADER	CC 52(34)	0(00) - 127(7F)	16	2
S6	TRACK 14 FADER	CC 53(35)	0(00) - 127(7F)	16	2
S7	TRACK 15 FADER	CC 54(36)	0(00) - 127(7F)	16	2
S8	TRACK 16 FADER	CC 55(37)	0(00) - 127(7F)	16	2
B1	TRACK 9 SOLO	CC 32(20)	0(00) / 127(7F)	16	2
B2	TRACK 10 SOLO	CC 33(21)	0(00) / 127(7F)	16	2
B3	TRACK 11 SOLO	CC 34(22)	0(00) / 127(7F)	16	2
B4	TRACK 12 SOLO	CC 35(23)	0(00) / 127(7F)	16	2
B5	TRACK 13 SOLO	CC 36(24)	0(00) / 127(7F)	16	2
B6	TRACK 14 SOLO	CC 37(25)	0(00) / 127(7F)	16	2
L1	<<	CC 20(14)	0(00) / 127(7F)	16	2
L2	■ Stop	CC 21(15)	0(00) / 127(7F)	16	2
L3	Rec	CC 23(17)	0(00) / 127(7F)	16	2
P1	HOLD	CC 64(40)	0(00) / 127(7F)	1	1
P2	EXPRESSION	CC 11(0B)	0(00) - 127(7F)	1	1

	Parameter	Message (Hex.)	Range (Hex.)	Ch.	Port
R1	TRACK 9 PAN	CC 56(38)	0(00) - 127(7F)	16	2
R2	TRACK 10 PAN	CC 57(39)	0(00) - 127(7F)	16	2
R3	TRACK 11 PAN	CC 58(3A)	0(00) - 127(7F)	16	2
R4	TRACK 12 PAN	CC 59(3B)	0(00) - 127(7F)	16	2
R5	TRACK 13 PAN	CC 60(3C)	0(00) - 127(7F)	16	2
R6	TRACK 14 PAN	CC 61(3D)	0(00) - 127(7F)	16	2
R7	TRACK 15 PAN	CC 62(3E)	0(00) - 127(7F)	16	2
R8	TRACK 16 PAN	CC 63(3F)	0(00) - 127(7F)	16	2
S1	TRACK 9 FADER	CC 48(30)	0(00) - 127(7F)	16	2
S2	TRACK 10 FADER	CC 49(31)	0(00) - 127(7F)	16	2
S3	TRACK 11 FADER	CC 50(32)	0(00) - 127(7F)	16	2
S4	TRACK 12 FADER	CC 51(33)	0(00) - 127(7F)	16	2
S5	TRACK 13 FADER	CC 52(34)	0(00) - 127(7F)	16	2
S6	TRACK 14 FADER	CC 53(35)	0(00) - 127(7F)	16	2
S7	TRACK 15 FADER	CC 54(36)	0(00) - 127(7F)	16	2
S8	TRACK 16 FADER	CC 55(37)	0(00) - 127(7F)	16	2
B1	TRACK 9 MUTE	CC 88(58)	0(00) / 127(7F)	16	2
B2	TRACK 10 MUTE	CC 89(59)	0(00) / 127(7F)	16	2
B3	TRACK 11 MUTE	CC 90(5A)	0(00) / 127(7F)	16	2
B4	TRACK 12 MUTE	CC 91(5B)	0(00) / 127(7F)	16	2
B5	TRACK 13 MUTE	CC 92(5C)	0(00) / 127(7F)	16	2
B6	TRACK 14 MUTE	CC 93(5D)	0(00) / 127(7F)	16	2
L1	<<	CC 20(14)	0(00) / 127(7F)	16	2
L2	■ Stop	CC 21(15)	0(00) / 127(7F)	16	2
L3	Rec	CC 23(17)	0(00) / 127(7F)	16	2
P1	HOLD	CC 64(40)	0(00) / 127(7F)	1	1
P2	EXPRESSION	CC 11(0B)	0(00) - 127(7F)	1	1

■ H-COMPATIBLE (ProTools LE, Digital Performer 3) SET (MEMORY: 9)

When using this memory set, turn the PCR-1's **OMNI** (p. 54) setting OFF, and turn the **H-ACTIVITY** (p. 95) setting ON.

	Parameter	Message (Hex.)	Range (Hex.)	Ch.	Port
R1	ROTARY ENCODER 1	B0 40 dd	DEC(01) / INC(41)	-	2
R2	ROTARY ENCODER 2	B0 41 dd	DEC(01) / INC(41)	-	2
R3	ROTARY ENCODER 3	B0 42 dd	DEC(01) / INC(41)	-	2
R4	ROTARY ENCODER 4	B0 43 dd	DEC(01) / INC(41)	-	2
R5	ROTARY ENCODER 5	B0 44 dd	DEC(01) / INC(41)	-	2
R6	ROTARY ENCODER 6	B0 45 dd	DEC(01) / INC(41)	-	2
R7	ROTARY ENCODER 7	B0 46 dd	DEC(01) / INC(41)	-	2
R8	ROTARY ENCODER 8	B0 47 dd	DEC(01) / INC(41)	-	2
S1	FADER 1	B0 0F 00 B0 2F 40 B0 00 dd B0 20 00 B0 0F 00 B0 2F 00	0(00) - 127(7F)	-	2
S2	FADER 2	B0 0F 01 B0 2F 40 B0 01 dd B0 21 00 B0 0F 01 B0 2F 00	0(00) - 127(7F)	-	2
S3	FADER 3	B0 0F 02 B0 2F 40 B0 02 dd B0 22 00 B0 0F 02 B0 2F 00	0(00) - 127(7F)	-	2
S4	FADER 4	B0 0F 03 B0 2F 40 B0 03 dd B0 23 00 B0 0F 03 B0 2F 00	0(00) - 127(7F)	-	2
S5	FADER 5	B0 0F 04 B0 2F 40 B0 04 dd B0 24 00 B0 0F 04 B0 2F 00	0(00) - 127(7F)	-	2
S6	FADER 6	B0 0F 05 B0 2F 40 B0 05 dd B0 25 00 B0 0F 05 B0 2F 00	0(00) - 127(7F)	-	2
S7	FADER 7	B0 0F 06 B0 2F 40 B0 06 dd B0 26 00 B0 0F 06 B0 2F 00	0(00) - 127(7F)	-	2
S8	FADER 8	B0 0F 07 B0 2F 40 B0 07 dd B0 27 00 B0 0F 07 B0 2F 00	0(00) - 127(7F)	-	2
B1	MUTE 1	B0 0F 00 B0 2F dd	ON(42) / OFF(02)	-	2
B2	SOLO 1	B0 0F 00 B0 2F dd	ON(43) / OFF(03)	-	2
B3	REC 1	B0 0F 00 B0 2F dd	ON(47) / OFF(07)	-	2
B4	WRITE 1	B0 0F 00 B0 2F dd	ON(44) / OFF(04)	-	2
B5	TRACK <	B0 0F 0A B0 2F dd	ON(40) / OFF(00)	-	2
B6	TRACK >	B0 0F 0A B0 2F dd	ON(42) / OFF(02)	-	2
L1	REWIND	B0 0F 0E B0 2F dd	ON(41) / OFF(01)	-	2
L2	STOP	B0 0F 0E B0 2F dd	ON(43) / OFF(03)	-	2
L3	PLAY	B0 0F 0E B0 2F dd	ON(44) / OFF(04)	-	2
P1	HOLD	CC 64(40)	0(00) / 127(7F)	1	1
P2	EXPRESSION	CC 11(0B)	0(00) - 127(7F)	1	1

■ GS SET

When using this memory set, you will find it convenient to turn the PCR-1's **OMNI** (p. 54) setting ON.

GS-A (MEMORY: A)

	Parameter	Message (Hex.)	Range (Hex.)	Ch.	Port
R1	REVERB MACRO	F0 41 10 42 12 40 01 30 dd SUM F7	0(00) - 7(07)	-	1
R2	REVERB CHARACTER	F0 41 10 42 12 40 01 31 dd SUM F7	0(00) - 7(07)	-	1
R3	REVERB PRE-LPF	F0 41 10 42 12 40 01 32 dd SUM F7	0(00) - 7(07)	-	1
R4	REVERB TIME	F0 41 10 42 12 40 01 34 dd SUM F7	0(00) - 127(7F)	-	1
R5	REVERB PREDELAY TIME	F0 41 10 42 12 40 01 37 dd SUM F7	0(00) - 127(7F)	-	1
R6	REVERB DELAY FEEDBACK	F0 41 10 42 12 40 01 35 dd SUM F7	0(00) - 127(7F)	-	1
R7	REVERB LEVEL	F0 41 10 42 12 40 01 33 dd SUM F7	0(00) - 127(7F)	-	1
R8	PART PANPOT	F0 41 10 42 12 40 1x 1C dd SUM F7	1(01) - 127(7F)	BLOCK	1
S1	VIBRATO RATE	F0 41 10 42 12 40 1x 30 dd SUM F7	0(00) - 64(40) - 127(7F)	BLOCK	1
S2	VIBRATO DEPTH	F0 41 10 42 12 40 1x 31 dd SUM F7	0(00) - 64(40) - 127(7F)	BLOCK	1
S3	VIBRATO DELAY	F0 41 10 42 12 40 1x 37 dd SUM F7	0(00) - 64(40) - 127(7F)	BLOCK	1
S4	TVF&TV A ENV. ATTACK	F0 41 10 42 12 40 1x 34 dd SUM F7	0(00) - 64(40) - 127(7F)	BLOCK	1
S5	TVF&TV A ENV. DECAY	F0 41 10 42 12 40 1x 35 dd SUM F7	0(00) - 64(40) - 127(7F)	BLOCK	1
S6	TVF&TV A ENV. RELEASE	F0 41 10 42 12 40 1x 36 dd SUM F7	0(00) - 64(40) - 127(7F)	BLOCK	1
S7	REVERB SEND LEVEL	F0 41 10 42 12 40 1x 22 dd SUM F7	0(00) - 127(7F)	BLOCK	1
S8	PART LEVEL	F0 41 10 42 12 40 00 7F 00 41 F7	0(00) - 127(7F)	BLOCK	1
B1	PROGRAM CHANGE DEC	PROGRAM CHANGE	min:1(00)	-	-
B2	PROGRAM CHANGE INC	PROGRAM CHANGE	max:128(7F)	-	-
B3	NRPN ON/OFF	F0 41 10 42 12 40 1x 0A dd SUM F7	OFF(00) / ON(01)	BLOCK	1
B4	RANDOM PAN	F0 41 10 42 12 40 1x 1C 00 SUM F7	-	BLOCK	1
B5	MODE POLY/MONO	F0 41 10 42 12 40 1x 13 dd SUM F7	MONO(00) / POLY(01)	BLOCK	1
B6	GS RESET	F0 41 10 42 12 40 00 7F 00 41 F7	-	-	1
L1	STOP	FC	-	-	2
L2	START	FA	-	-	2
L3	CONTINUE	FB	-	-	2
P1	HOLD	CC 64(40)	0(00) / 127(7F)	1	1
P2	EXPRESSION	CC 11(0B)	0(00) - 127(7F)	1	1

GS-B (MEMORY: B)

	Parameter	Message (Hex.)	Range (Hex.)	Ch.	Port
R1	CHORUS MACRO	F0 41 10 42 12 40 01 38 dd SUM F7	0(00) - 7(07)	-	1
R2	CHORUS PRE-LPF	F0 41 10 42 12 40 01 39 dd SUM F7	0(00) - 7(07)	-	1
R3	CHORUS DELAY	F0 41 10 42 12 40 01 3C dd SUM F7	0(00) - 127(7F)	-	1
R4	CHORUS RATE	F0 41 10 42 12 40 01 3D dd SUM F7	0(00) - 127(7F)	-	1
R5	CHORUS DEPTH	F0 41 10 42 12 40 01 3E dd SUM F7	0(00) - 127(7F)	-	1
R6	CHORUS FEEDBACK	F0 41 10 42 12 40 01 3B dd SUM F7	0(00) - 127(7F)	-	1
R7	CHORUS LEVEL	F0 41 10 42 12 40 01 3A dd SUM F7	0(00) - 127(7F)	-	1
R8	PART PANPOT	F0 41 10 42 12 40 1x 1C dd SUM F7	1(01) - 127(7F)	BLOCK	1
S1	CHORUS SEND LEVEL TO REVERB	F0 41 10 42 12 40 01 3F dd SUM F7	0(00) - 64(40) - 127(7F)	BLOCK	1
S2	CHORUS SEND LEVEL TO DELAY	F0 41 10 42 12 40 01 40 dd SUM F7	0(00) - 64(40) - 127(7F)	BLOCK	1
S3	TVF CUTOFF FREQ	F0 41 10 42 12 40 1x 32 dd SUM F7	0(00) - 64(40) - 127(7F)	BLOCK	1
S4	TVF RESONANCE	F0 41 10 42 12 40 1x 33 dd SUM F7	0(00) - 64(40) - 127(7F)	BLOCK	1
S5	MODULATION DEPTH	F0 41 10 42 12 40 2x 04 dd SUM F7	0(00) - 127(7F)	BLOCK	1
S6	BEND RANGE	F0 41 10 42 12 40 2x 10 dd SUM F7	64(40) - 88(58)	BLOCK	1
S7	CHORUS SEND LEVEL	F0 41 10 42 12 40 1x 21 dd SUM F7	0(00) - 127(7F)	BLOCK	1
S8	PART LEVEL	F0 41 10 42 12 40 1x 19 dd SUM F7	0(00) - 127(7F)	BLOCK	1
B1	PROGRAM CHANGE DEC	PROGRAM CHANGE	min:1 (00)	-	-
B2	PROGRAM CHANGE INC	PROGRAM CHANGE	max:128 (7F)	-	-
B3	NRPN ON/OFF	F0 41 10 42 12 40 1x 0A dd SUM F7	OFF(00) / ON(01)	BLOCK	1
B4	RANDOM PAN	F0 41 10 42 12 40 1x 1C 00 SUM F7	-	BLOCK	1
B5	MODE POLY/MONO	F0 41 10 42 12 40 1x 13 dd SUM F7	MONO(00) / POLY(01)	BLOCK	1
B6	GS RESET	F0 41 10 42 12 40 00 7F 00 41 F7	-	-	1
L1	STOP	FC	-	-	2
L2	START	FA	-	-	2
L3	CONTINUE	FB	-	-	2
P1	HOLD	CC 64(40)	0(00) / 127(7F)	1	1
P2	EXPRESSION	CC 11(0B)	0(00) - 127(7F)	1	1

GS-C (MEMORY: C)

	Parameter	Message (Hex.)	Range (Hex.)	Ch.	Port
R1	DELAY MACRO	F0 41 10 42 12 40 01 50 dd SUM F7	0(00) - 9(09)	-	1
R2	DELAY PRE-LPF	F0 41 10 42 12 40 01 51 dd SUM F7	0(00) - 7(07)	-	1
R3	DELAY TIME RATIO LEFT	F0 41 10 42 12 40 01 53 dd SUM F7	1(01) - 120(78)	-	1
R4	DELAY TIME CENTER	F0 41 10 42 12 40 01 52 dd SUM F7	1(01) - 115(73)	-	1
R5	DELAY TIME RATIO RIGHT	F0 41 10 42 12 40 01 54 dd SUM F7	1(01) - 120(78)	-	1
R6	DELAY FEEDBACK	F0 41 10 42 12 40 01 59 dd SUM F7	0(00) - 64(40) - 127(7F)	-	1
R7	DELAY LEVEL	F0 41 10 42 12 40 01 58 dd SUM F7	0(00) - 127(7F)	-	1
R8	PART PANPOT	F0 41 10 42 12 40 1x 1C dd SUM F7	1(01) - 127(7F)	BLOCK	1
S1	DELAY SEND LEVEL TO REVERB	F0 41 10 42 12 40 01 5A dd SUM F7	0(00) - 127(7F)	-	1
S2	DELAY LEVEL LEFT	F0 41 10 42 12 40 01 56 dd SUM F7	0(00) - 127(7F)	-	1
S3	DELAY LEVEL CENTER	F0 41 10 42 12 40 01 55 dd SUM F7	0(00) - 127(7F)	-	1
S4	DELAY LEVEL RIGHT	F0 41 10 42 12 40 01 57 dd SUM F7	0(00) - 127(7F)	-	1
S5	EQ LOW GAIN	F0 41 10 42 12 40 02 01 dd SUM F7	22(34) - 64(40) - 76(4C)	-	1
S6	EQ HIGH GAIN	F0 41 10 42 12 40 02 03 dd SUM F7	22(34) - 64(40) - 76(4C)	-	1
S7	DELAY SEND LEVEL	F0 41 10 42 12 40 1x 2C dd SUM F7	0(00) - 127(7F)	BLOCK	1
S8	PART LEVEL	F0 41 10 42 12 40 1x 19 dd SUM F7	0(00) - 127(7F)	BLOCK	1
B1	EQ ON / OFF	F0 41 10 42 12 40 4x 20 dd SUM F7	OFF(00) / ON(01)	BLOCK	1
B2	EQ LOW FREQ (200Hz/400Hz)	F0 41 10 42 12 40 02 00 dd SUM F7	200Hz(00) / 400Hz(01)	-	1
B3	EQ HIGH FREQ (3kHz/6kHz)	F0 41 10 42 12 40 02 02 dd SUM F7	3kHz(00) / 6kHz(01)	-	1
B4	RANDOM PAN	F0 41 10 42 12 40 1x 1C 00 SUM F7	-	BLOCK	1
B5	MODE POLY/MONO	F0 41 10 42 12 40 1x 13 dd SUM F7	MONO(00) / POLY(01)	BLOCK	1
B6	GS RESET	F0 41 10 42 12 40 00 7F 00 41 F7	-	-	1
L1	STOP	FC	-	-	2
L2	START	FA	-	-	2
L3	CONTINUE	FB	-	-	2
P1	HOLD	CC 64(40)	0(00) / 127(7F)	1	1
P2	EXPRESSION	CC 11(0B)	0(00) - 127(7F)	1	1

■ XG SET

When using this memory set, you will find it convenient to turn the PCR-1's **OMNI** (p. 54) setting ON.

XG-A (MEMORY: D)

Parameter	Message (Hex.)	Range (Hex.)	Ch.	Port
R1 BEND PITCH CONTROL	F0 43 10 4C 08 0ch 23 dd F7	0(00) - 64(40) - 127(7F)	CURRENT CH	1
R2 BEND FILTER CONTROL	F0 43 10 4C 08 0ch 24 dd F7	0(00) - 64(40) - 127(7F)	CURRENT CH	1
R3 BEND AMPLITUDE CONTROL	F0 43 10 4C 08 0ch 25 dd F7	0(00) - 64(40) - 127(7F)	CURRENT CH	1
R4 PITCH EG INITIAL LEVEL	F0 43 10 4C 08 0ch 69 dd F7	0(00) - 64(40) - 127(7F)	CURRENT CH	1
R5 PITCH EG ATTACK TIME	F0 43 10 4C 08 0ch 6A dd F7	0(00) - 64(40) - 127(7F)	CURRENT CH	1
R6 PITCH EG RELEASE LEVEL	F0 43 10 4C 08 0ch 6B dd F7	0(00) - 64(40) - 127(7F)	CURRENT CH	1
R7 PITCH EG RELEASE TIME	F0 43 10 4C 08 0ch 6C dd F7	0(00) - 64(40) - 127(7F)	CURRENT CH	1
R8 PAN	F0 43 10 4C 08 0ch 0E dd F7	1(01) - 64(40) - 127(7F)	CURRENT CH	1
S1 BEND LFO PMOD DEPTH	F0 43 10 4C 08 0ch 26 dd F7	0(00) - 127(7F)	CURRENT CH	1
S2 BEND LFO FMOD DEPTH	F0 43 10 4C 08 0ch 27 dd F7	0(00) - 127(7F)	CURRENT CH	1
S3 BEND LFO AMOD DEPTH	F0 43 10 4C 08 0ch 28 dd F7	0(00) - 127(7F)	CURRENT CH	1
S4 REVERB SEND	F0 43 10 4C 08 0ch 13 dd F7	0(00) - 127(7F)	CURRENT CH	1
S5 CHORUS SEND	F0 43 10 4C 08 0ch 12 dd F7	0(00) - 127(7F)	CURRENT CH	1
S6 VARIATION SEND	F0 43 10 4C 08 0ch 14 dd F7	0(00) - 127(7F)	CURRENT CH	1
S7 DRY LEVEL	F0 43 10 4C 08 0ch 11 dd F7	0(00) - 127(7F)	CURRENT CH	1
S8 VOLUME	F0 43 10 4C 08 0ch 0B dd F7	0(00) - 127(7F)	CURRENT CH	1
B1 PROGRAM CHANGE DEC	PROGRAM CHANGE	min:1 (00)	-	-
B2 PROGRAM CHANGE INC	PROGRAM CHANGE	max:128 (7F)	-	-
B3 PART MODE NORMAL/DRUM	F0 43 10 4C 08 0ch 07 dd F7	OFF(00) / ON(01)	CURRENT CH	1
B4 RANDOM PAN	F0 43 10 4C 08 0ch 0E 00 F7	-	CURRENT CH	1
B5 MONO/POLY MODE	F0 43 10 4C 08 0ch 05 dd F7	MONO(00) / POLY(01)	CURRENT CH	1
B6 XG SYSTEM ON	F0 43 10 4C 00 00 7E 00 F7	-	-	1
L1 STOP	FC	-	-	2
L2 START	FA	-	-	2
L3 CONTINUE	FB	-	-	2
P1 HOLD	CC 64(40)	0(00) / 127(7F)	1	1
P2 EXPRESSION	CC 11(0B)	0(00) - 127(7F)	1	1

XG-B (MEMORY: E)

Parameter	Message (Hex.)	Range (Hex.)	Ch.	Port
R1 MW PITCH CONTROL	F0 43 10 4C 08 0ch 1D dd F7	0(00) - 64(40) - 127(7F)	CURRENT CH	1
R2 MW FILTER CONTROL	F0 43 10 4C 08 0ch 1E dd F7	0(00) - 64(40) - 127(7F)	CURRENT CH	1
R3 MW AMPLITUDE CONTROL	F0 43 10 4C 08 0ch 1F dd F7	0(00) - 64(40) - 127(7F)	CURRENT CH	1
R4 REVERB PAN	F0 43 10 4C 02 01 0D dd F7	0(00) - 64(40) - 127(7F)	-	1
R5 CHORUS PAN	F0 43 10 4C 02 01 2D dd F7	0(00) - 64(40) - 127(7F)	-	1
R6 VARIATION PAN	F0 43 10 4C 02 01 57 dd F7	0(00) - 64(40) - 127(7F)	-	1
R7 SEND VARIATION TO REVERB	F0 43 10 4C 02 01 58 dd F7	0(00) - 127(7F)	-	1
R8 SEND VARIATION TO CHORUS	F0 43 10 4C 02 01 59 dd F7	0(00) - 127(7F)	-	1
S1 MW LFO PMOD DEPTH	F0 43 10 4C 08 0ch 20 dd F7	0(00) - 127(7F)	CURRENT CH	1
S2 MW LFO FMOD DEPTH	F0 43 10 4C 08 0ch 21 dd F7	0(00) - 127(7F)	CURRENT CH	1
S3 MW LFO AMOD DEPTH	F0 43 10 4C 08 0ch 22 dd F7	0(00) - 127(7F)	CURRENT CH	1
S4 REVERB RETURN	F0 43 10 4C 02 01 0C dd F7	0(00) - 127(7F)	-	1
S5 CHORUS RETURN	F0 43 10 4C 02 01 2C dd F7	0(00) - 127(7F)	-	1
S6 VARIATION RETURN	F0 43 10 4C 02 01 56 dd F7	0(00) - 127(7F)	-	1
S7 SEND CHORUS TO REVERB	F0 43 10 4C 02 01 2E dd F7	0(00) - 127(7F)	-	1
S8 VOLUME	F0 43 10 4C 08 0ch 0B dd F7	0(00) - 127(7F)	CURRENT CH	1
B1 PROGRAM CHANGE DEC	PROGRAM CHANGE	min:1 (00)	-	-
B2 PROGRAM CHANGE INC	PROGRAM CHANGE	max:128 (7F)	-	-
B3 PART MODE NORMAL/DRUM	F0 43 10 4C 08 0ch 07 dd F7	OFF(00) / ON(01)	CURRENT CH	1
B4 RANDOM PAN	F0 43 10 4C 08 0ch 0E 00 F7	-	CURRENT CH	1
B5 MONO/POLY MODE	F0 43 10 4C 08 0ch 05 dd F7	MONO(00) / POLY(01)	CURRENT CH	1
B6 XG SYSTEM ON	F0 43 10 4C 00 00 7E 00 F7	-	-	1
L1 STOP	FC	-	-	2
L2 START	FA	-	-	2
L3 CONTINUE	FB	-	-	2
P1 HOLD	CC 64(40)	0(00) / 127(7F)	1	1
P2 EXPRESSION	CC 11(0B)	0(00) - 127(7F)	1	1

Troubleshooting



Problems common to Windows and Macintosh



Problems occurring only in Windows



Problems occurring only in Macintosh

Trouble shooting is organized according to different operating systems. Refer to the icon(s) at the left of the title to find your items you need.

** For details on operating your Windows or Macintosh computer, refer to the owner's manual of the computer and operating system you are using.*

Problems related to the USB driver



Cannot install the driver correctly

Did you make the correct connections and settings for installation? Check each one of the following items.

- **Is the PCR-1 connected correctly?**

Make sure that the USB connector of your computer is connected to the PCR-1 by a USB cable.

- **Is the CD-ROM correctly inserted into your CD-ROM drive?**

Installation is not possible unless the CD-ROM included with the PCR-1 is inserted in your CD-ROM drive. Make sure that the CD-ROM is correctly inserted into your CD-ROM drive.

- **Is the CD-ROM or the lens of the CD-ROM dirty?**

If the CD-ROM or the lens of the CD-ROM drive is dirty, the installer may not work correctly. Clean the disc and/or lens using a commercially-available CD cleaner or lens cleaner.

- **Are you installing the software from a networked CD-ROM drive?**

The software cannot be installed from a networked CD-ROM drive.

- **Could other applications or resident software (such as antivirus programs) be running?**

Installation may not be successful if other programs are running. Be sure to close all other programs before installation.

- **Is your computer's power-conservation mode turned off?**

If power-conservation settings are enabled on your computer, please disable any such settings. (For the procedure, refer to the owner's manual of your computer.)

- **Could any other USB device be connected?**

Before you install, disconnect all USB devices except for your mouse and keyboard.

- **Is there sufficient free space on your hard disk?**

Delete unneeded files to increase the amount of free space. After deleting the unneeded files, empty the recycling bin.

- **Is USB enabled on your computer?**

Refer to the operation manual for your computer, and make sure that USB is enabled.



Device Manager indicate any of these: “Other device,” “Unknown device,” or a device for which “?” , “!” or “x” is displayed?

If the driver installation could not be successfully completed, the installed driver may remain in an incomplete state. Make sure to install the driver over again(p. 14).



You attempted to install using the procedure in “Installing the driver,” but the installation was not successful.

Use the procedure in **Deleting the driver** (p. 110) to uninstall the driver.

Then set the PCR to the following driver mode, turn the PCR’s power on again, and install the driver once again.]

“**USB MIDI DRIVER MODE** “ (p. 95) 0: Original driver

“**USB AUDIO MODE SETTING**” (p. 96) 0: 44.1kHz (ADVANCE)



Is OMS or FreeMIDI installed? (Mac OS 9)

The PCR-1 driver cannot be installed unless OMS or FreeMIDI are installed. Please install **OMS** or **FreeMIDI**.



PCR-1 is not detected when making OMS or FreeMIDI settings (Mac OS 9 users)

- **Is the PCR-1 detected?**

- Reconnect the USB cable.
- If other USB devices are connected, connect only the PCR-1.
- It is possible that the Macintosh did not correctly detect and initialize the PCR-1. Leave the PCR-1’s USB cable connected, and restart your Macintosh. If it is still not detected, shut down your Macintosh, and then restart it.
- In some cases, the PCR-1 will not be detected if you have connected it to the USB connector located on the keyboard of the Macintosh. Please connect it to a USB connector on the Macintosh itself.



The “Insert Disk” dialog box does not appear

It is possible that the unsuccessfully installed driver is still present.

Turn off the power of your computer, and then install the driver once again.



Cannot install the driver correctly “Find new hardware wizard” does not execute automatically



The “Insert Disk” dialog box does not appear



The “Insert Disk” dialog box does not appear “Find new hardware wizard” ends before the process is completed

- **It may take about 15 seconds (or more) after the USB cable is connected for the PCR-1 to be detected.**
- **Is the USB cable connected correctly?**
Make sure that the PCR-1 and your computer are correctly connected via a USB cable.
- **Is USB enabled on your computer?**
Refer to the operation manual for your computer, and make sure that USB is enabled.
- **Does your computer or USB hub have sufficient power supply capacity?**
The PCR-1 cannot be connected if insufficient power is supplied to it. Check whether one of the following cases apply.
 - If you are using the PCR-1 with a notebook computer that is running on its battery, operation may be unreliable with some models of computer. If this is the case, connect the AC adaptor to your notebook computer.
 - The power conservation mode of your computer may limit the power that is supplied to USB. Check the settings of your computer.
 - In some cases, the PCR-1 cannot be used with a bus-powered hub (a hub that does not contain a power supply). Please use a self-powered hub (a hub that contains a power supply).
- **It has been found that in some cases, not all of the Windows 98 files required to support audio via USB are installed when a computer is shipped.**
Please contact the manufacturer of your computer.
- **Does your computer meet the USB specifications?**
If you are using a computer that does not fulfill the electrical requirements of the USB specifications, operation may be unstable. In this case, you may be able to solve the problem by connecting a USB hub.
If the above actions do not solve the problem, it is possible that the PCR-1 has been incorrectly detected by the computer. Please reinstall the driver from the beginning of the procedure. (**Getting Connected and Installing Drivers (Windows)** (p. 14))



“Found unknown device” appears even though you installed the driver

If your computer or USB hub has two or more USB connectors, and you connect the PCR-1 to a USB connector to which the PCR-1 has never been connected before, the “**Unknown device**” dialog box may appear even on a computer onto which you have already installed the driver.

Refer to **Installing the driver** (p. 14), and install the driver once again. This is not a malfunction.

If the “**Found unknown device**” dialog box appears even though the PCR-1 is connected to the same USB connector as before, it is possible that the computer has detected the PCR-1 incorrectly. Please reinstall the driver from the beginning of the procedure (p. 14).



Can't install/delete/use the driver in Windows XP/2000

- **Did you log on to Windows as a user with administrative privileges?**
In order to install/delete/re-install the driver in Windows XP/2000, you must be logged into Windows as a user with administrative privileges, such as Administrator. For details, please contact the system administrator for your computer system.
- **Did you make “Driver Signing Options”?**
- **In order to install/re-install the driver, you must make “Driver Signing Options”.**
(→**Windows XP** (p. 14), **Windows 2000** (p. 20))



Windows XP/2000 displays a “Hardware Installation” or “Digital Signature Not Found” dialog box

- **Did you make “Driver Signing Options”?**
In order to install/re-install the driver, you must make the settings described in “**Driver Signing Options**”.
(→**Windows XP** (p. 14), **Windows 2000** (p. 20))

■ Deleting the driver

If you were unable to install the driver according to the procedure given, the PCR-1 may not be recognized correctly by the computer. In this case, use the following procedure to delete the driver, and then follow the procedure to install the driver once again.

Windows users

Here's how to uninstall the dedicated driver.

1

Start up Windows with the PCR-1 disconnected.

Disconnect all USB cables other than a USB keyboard or USB mouse.

** If you are using Windows XP Professional/2000, log on as a user that has administrative privileges (e.g., Administrator).*

2

Insert the CD-ROM into the CD-ROM drive of your computer.

3

From the Windows **Start menu**, choose "**Run...**".

In the **Run** dialog box, input the following into the **Open** field, and click **[OK]**.

Windows XP/2000 users: **D:\DRIVER\USB_XP2K\Uninstal.EXE**

Windows Me/98 users: **D:\DRIVER\USB_ME98\Uninstal.EXE**

** The drive name D: may be different on your system. Use the drive name for your CD-ROM drive.*

4

Follow the on-screen instructions to uninstall the driver.

Macintosh (Mac OS 9) users

1

Turn off the power of the PCR-1.

Also disconnect the USB cable (by which the PCR-1 is connected) from your Macintosh.

2

From the **system extensions** folder, drag "**USB PCR-1 Driver**" and "**USB PCR-1Audio Driver**" into the trash to delete it.

3

Delete **PCR-1** from the **OMS Folder** inside the **System folder**, or drag **PCR-1 Driver** from the **FreeMIDI Folder** inside the **System folder** to the **trash**.

4

Restart the Macintosh.

Problems when using the PCR-1

Operating system becomes unstable

Operation becomes unstable when the computer is started up with the PCR-1 already connected

Please start up your computer with the PCR-1 disconnected, and then connect the PCR-1. On a computer that uses a USB keyboard, starting up the computer with the PCR-1 already connected may cause operation to become unstable. In this case, start up the computer with the PCR-1 disconnected, and then connect the PCR-1.

Can't hear sound from the computer

- **Do the recording and playback sampling frequencies match?**
Set the recording and playback sampling frequencies so they match.
- **The PCR-1's Sampling frequency select switch may have been set to "96 kHz REC".**
With this setting, only recording is possible. Sound from the computer cannot be played back.
- **In your playback software, have you specified the audio data output destination?**
For some software, such as Cool Edit Pro LE, you will need to specify the **PCR-1** as the output destination for audio data. For details on the procedure for making settings, refer to the owner's manual for your software.
- **Are you running multiple applications?**
If multiple applications are running simultaneously, an error message may appear. If this occurs, click **[OK]** and exit the other applications.
Even if an application window is closed, it is still running if it appears in the taskbar. Be sure to exit unneeded applications displayed.
- **Was the driver installed correctly?**
In order for you to play back audio data via the PCR-1, the driver must be installed. For installation and settings, refer to "**Getting Connected and Installing Drivers**" (→**Windows** (p. 14), **Macintosh** (p. 31)).
- **Is your computer in Suspend or Sleep mode?**
If so, get your computer to resume normal operation, then exit all applications that are using the PCR-1. Next, turn the PCR-1's power off, then switch it on again.
- **Did you plug in the USB cable, or unplug it while an application was running?**
Exit all applications that are using the PCR-1, and exit all applications that are using the PCR-1, and re-connect the PCR-1.
- **Have you selected a "Game compatible device" or "Voice modem" as the output for the audio track?**
If game compatible device or voice modem (the actual name will depend on the computer you are using) is selected for the audio track of your software, the audio track may not play back. Do not select these devices as the port.

Volume from a device connected to the input jacks is too low

Are you using a cable that has a built-in resistor?

Use a cable without a built-in resistor (e.g., Roland PCS series).

- **Is the Input volume raised appropriately?**
Turn the knob clockwise to adjust the volume.

Noise is heard during audio playback

In some cases, you may also be able to solve this problem by grounding the chassis of your computer, or the grounding connector of the AC power supply plug of your computer. In addition, you can check whether any devices that produce a strong magnetic field are located nearby, such as a television or microwave oven.

- **Are two or more audio devices such as the PCR-1 or a mixer connected to your computer?**

Try connecting only a single PCR-1 unit, and check whether the noise disappears. If numerous audio devices are connected to a computer, noise may occur depending on your system. In such cases, connect only the PCR-1 to your computer.

Does your sequencer software support ASIO 2.0 or 24-bit audio?

If your ASIO-compatible software does not support ASIO 2.0, it will not operate correctly if you use **[PCR-1 ASIO2.0 16bit]** or **[PCR-1 ASIO2.0 24bit]** as the ASIO driver.

In this case, select either **[PCR-1 ASIO1.0 16bit]** or **[PCR-1 ASIO1.0 24bit]** as the ASIO driver.

If your ASIO-compatible software does not support 24-bit audio input/output, it will not operate correctly if you select **[PCR-1 ASIO1.0 24bit]** or **[PCR-1 ASIO2.0 24bit]** as the ASIO driver. In this case, select either **[PCR-1 ASIO1.0 16bit]** or **[PCR-1 ASIO2.0 16bit]** as the ASIO driver.

Graphic accelerators may cause noise to be heard during audio playback.

Use the following procedure to turn the graphic accelerator “Off.”

1. In the Windows **Control Panel**, double-click the **Screen Properties** dialog box, and click the **Settings** tab.
2. Click **Details**, and in the properties that appear, click the **Performance** tab. For Windows 2000, click the **Troubleshooting** tab.
3. In the graphic, set the **Hardware accelerator** slider to **None**, and click **[OK]**.
4. In the **Screen Properties** dialog box, click **[OK]** to close the dialog box. Then restart your computer.

Try using the following procedure to change your disk drive settings.

The following setting item may not exist on some computers.

1. In the Windows **Control Panel**, double-click **System**.
2. Click the **Device Manager** tab.
3. Double-click **Disk Drives** to see the **list of devices**.
4. From the list, select **GENERIC IDE DISK TYPE??**, and click Properties to access the **GENERIC IDE DISK TYPE?? Properties** dialog box.

* *In the ?? field of **GENERIC IDE DISK TYPE??***

memory.

will increase the performance of your computer. For details on how to refer to the operation manual for your computer.

Can my computer satisfy the requirements of the USB standard?

computer (such as a computer that you yourself assembled) that does not satisfy requirements of the USB specifications, you may experience interruptions in the playback. In some cases, you may be able to solve the problem by connecting a USB hub that contains a power supply.

Can I solve this problem in the “EDIROL PCR-1 Driver Troubleshooting” dialog box.

refer to the section “Part of the playbacks wrong: e.g., notes are broken or notes are lost” within the README_E file located in the folder in which you installed the CD-ROM.

On some computers, audio playback may be interrupted due to the Power Management settings in the Control Panel.

The Power Supply Properties that you see when you double-click **Power Management** will differ depending on your computer system. One example is given below, but you should also refer to the operation manual for your computer. Some computers may not have all of the following settings.

Click the Windows Start button, and select **Settings | Control Panel** to open the [Control Panel].

2. In **Control Panel**, double-click **System** to open the **System Properties** dialog box.
3. Click the **Device Manager** tab.
4. Double-click **System Devices** to display the list of devices.
5. From the list, select **Advanced Power Management Support**. Then click **Properties** to open the **Advanced Power Management Support Properties** dialog box.
6. Click the **Settings** tab, and in **Troubleshooting**, place a check in the check box for **Don't Poll Power Supply Status**. Then click [OK].
7. In the System Properties dialog box, click [OK].
8. Restart Windows.



Depending on the virtual memory setting or network-related settings, noise may occur.

Please make the following settings before use.

- **In Chooser of the Apple menu, set AppleTalk to “Inactive.”**(This setting is not changed as a result of turning off AppleTalk, as requested by OMS when sequencer software is started up. You must change the setting yourself using the “Chooser.”)
- **In the “Memory” Control Panel, set Virtual Memory to “Off.”**
- **Depending on the way in which you connect to the Internet, use the PCR-1 with the following settings.**
 - **If you connect to the Internet via a LAN cable**
Use while the LAN cable is connected.
 - **If you connect to the Internet via the internal modem port, or are not connected to the Internet**
In the **“TCP/IP” Control Panel**, set **“Connect via”** to **“PPP.”**
After you have made the settings, restart your Macintosh.
- * *Do not use software that accesses the network (such as a Web browser) at the same time that you are using sequencer software or audio editing software.*



Try increasing the Buffer Size in the ASIO Driver control panel.

The name of the settings dialog box will differ depending on your software.



- * *If you change the **buffer size**, you must exit the software and then restart it.*
- * *Roland can make no guarantee of, nor provide support regarding the operation of sequencer software and audio editing software made by another manufacturer. Please contact the manufacturer of the software you are using.*



Playback or recording halts midway through, and then becomes impossible

- **Was a heavy processing load experienced while using the PCR-1, such as accessing the CD-ROM drive or a network?**

If an operation involving a heavy processing load is performed while the PCR-1 is in use, it may not operate correctly. If this occurs, stop playback/recording, and then try resuming playback/recording. If you are still unable to play back/record, exit all applications that use the PCR-1, switch off the PCR-1, then turn it on again.



Can't record / play 24-bit audio data

- **Does your software support 24-bit audio data?**
- **Is your software set to record/play 24-bit audio data?**
- **Have you selected [PCR-1 ASIO1.0 24bit] or [PCR-1 ASIO2.0 24bit] as the ASIO driver?**



Recording produces a silent (blank) file

- **Try setting the bit rate to “16 bit or higher.”**

If you are using Windows 98 Second Edition and your recording software is set to a bit rate setting of 8 bits, a silent file may be created, effectively making recording impossible. If this occurs, set the bit rate to “**16 bit or higher**,” and you will be able to record normally.

- **In your operating system, is the audio data input destination set correctly?**
- **On your recording software, is the audio data input destination set correctly?**
- **The PCR-1's USB AUDIO MODE SETTING (p.96) select may have been set to “96 kHz PLAY”.**

When set to “**96 kHz PLAY**”, only **playback** is possible. If you want to record the sound from your computer, choose a setting other than “**96 kHz PLAY**”.



Can't record MIDI

- **Has the MIDI device you are using been set correctly?**
 Make the correct input/output device settings. (→**Input / output devices** (p. 44))
 Make sure that the PCR-1 is selected as the MIDI input/output device (port) in the software that you want to control. If the PCR-1 is connected via USB, you can use two ports for controlling your software. Make sure that the desired port is correctly selected. (→**Audio and MIDI flow** (p. 43))
- **Are you running multiple applications?**
 If multiple applications are running simultaneously, an error message may appear. If this occurs, click **[OK]** and exit the other applications.
 Even if an application window is closed, it is still running if it appears in the taskbar. Be sure to exit unneeded applications displayed.
- **Was the driver installed correctly?**
 In order for you to play back audio data via the PCR-1, the driver must be installed. For installation and settings, refer to “**Getting Connected and Installing Drivers**” (→**Windows** (p. 14)/**Macintosh** (p. 31)).
- **Could the power of your equipment be off?**
 Make sure that the power to your audio equipment (e.g., stereo) and the PCR-1 has been connected.
- **Are the volume controls of the PCR-1 set appropriately?**
 Use the PCR-1's front panel VOLUME knob to adjust the volume.
- **Is your computer in Suspend or Sleep mode?**
 If so, get your computer to resume normal operation, then exit all applications that are using the PCR-1. Next, disconnect the USB cable from the PCR-1, then connect it again.
- **Did you plug in the USB cable, or unplug it while an application was running?**
 Exit all applications that are using the PCR-1, and exit all applications that are using the PCR-1, and re-connect the PCR-1.



Is OMS/FreeMIDI set correctly?

As described in **OMS settings** (p. 34) or **FreeMIDI settings** (p. 36), check the OMS or FreeMIDI settings. Also make sure that the device for MIDI IN/OUT is correctly selected in the MIDI settings of your MIDI sequencer software.



Is the OMS setup enabled?

If a diamond-shaped symbol is not displayed at the left edge of the title area in the OMS setup window, the setup is not enabled. From the OMS File menu, choose “**Make Current**” (p. 35).

MIDI implementation

1. Receive data

■ System exclusive messages

● Universal non-realtime system exclusive message

○ Identity request message

Status	Data byte	Status
F0H	7EH, dev, 06H, 01H	F7H

Byte	Explanation
F0H	Exclusive status
7EH	ID number (Universal non-realtime system exclusive message)
dev	Device ID (10 or 7FH (Broadcast))
06H	Sub ID #1 (PCR-1)
01H	Sub ID #1 (PCR-1)
F7H	EOX (End of Exclusive)

● Data transmission

The PCR-1 can use Bulk Dump (p. 119) to transfer its internal **Memory sets** (p. 100).

○ Data Set 1 DT1 (12H)

These messages transmit the actual data, and are used to transfer data settings to a device.

Status	Data byte	Status
F0H	41H, 10H, 00H, 62H, 12H, aaH, ddH, ...eeH, sum	F7H

Byte	Explanation
F0H	Exclusive status
41H	ID number (Roland)
10H	Device ID (For the PCR-1, fixed at 10H)
00H	Model ID #1 (PCR-1)
62H	Model ID #1 (PCR-1)
12H	Command ID (RQ1)
aaH	Address
ddH	Data
:	:
:	:
:	:
eeH	Data
sum	Checksum
F7H	EOX (End of Exclusive)

* The amount of data that can be transmitted at once is fixed for each type of data. Data that does not have the specified starting address and data size will not be received. Refer to the explanation in 3. Bulk Dump (p. 119).

* There must be an interval of at least 40 ms between each exclusive message that is sent.

* Also, you must leave an interval of at least 500 ms after transmitting one set of bulk dump data.

2. Transmit data

■ Channel voice messages

In addition to the channel voice messages that can be transmitted in each mode, the PCR-1 lets you assign any channel voice message to any controller and transmit it.

● Note off

Status	2nd byte	3rd byte
9nH	kkH	00H

n = MIDI channel number: 0H – FH (Ch.1 – 16)
kk = note number: 00H – 7FH (0 – 127)

* Transmitted when you release a key in Play mode.

● Note on

Status	2nd byte	3rd byte
9nH	kkH	vvH

n = MIDI channel number: 0H – FH (Ch.1 – 16)
kk = note number: 00H – 7FH (0 – 127)
vv = note on velocity: 01H – 7FH (1 – 127)

* Transmitted when you push a key in Play mode.

● Polyphonic key pressure

Status	2nd byte	3rd byte
AnH	kkH	vvH

n = MIDI channel number: 0H – FH (Ch.1 – 16)
kk = note number: 00H – 7FH (0 – 127)
vv = key pressure: 00H – 7FH (0 – 127)

● Control change

Status	2nd byte	3rd byte
BnH	ccH	vvH

n = MIDI channel number: 0H – FH (Ch.1 – 16)
cc = controller number: 00H – 7FH
vv = control value: 00H – 7FH

○ Bank Select (Controller number 0, 32)

Status	2nd byte	3rd byte
BnH	00H	mmH
BnH	20H	llH

n = MIDI channel number: 0H – FH (Ch.1 – 16)
mm = Bank number MSB: 00H – 7FH
ll = Bank number LSB: 00H – 7FH

* Transmitted in Bank mode.

○ Modulation (Controller number 1)

Status	2nd byte	3rd byte
BnH	01H	vvH

n = MIDI channel number: 0H – FH (Ch.1 – 16)
vv = Modulation depth: 00H – 7FH (0 – 127)

* Transmitted by upward/downward operation of the BENDER lever in Play mode.

●Program change

<u>Status</u>	<u>2nd byte</u>
CnH	ppH

n = MIDI channel number: 0H – FH (Ch.1 – 16)
 pp = Program number: 00H – 7FH (prog. 1 – prog. 128)

* Transmitted in Program change mode.

●Channel pressure

<u>Status</u>	<u>2nd byte</u>
DnH	vvH

n = MIDI channel number: 0H – FH (Ch.1 – 16)
 vv = Channel pressure: 00H – 7FH (0 – 127)

●Pitch bend change

<u>Status</u>	<u>2nd byte</u>	<u>3rd byte</u>
EnH	llH	mmH

n = MIDI channel number: 0H – FH (Ch.1 – 16)
 mm, ll = Pitch Bend value: 00 00H – 40 00H – 7FH 7FH
 (-8192 – 0 – +8191)

* Transmitted by rightward/leftward operation of the BENDER lever in Play mode.

■Channel mode messages

In addition to the channel mode messages that can be transmitted in Panic mode, the PCR-1 lets you assign any channel voice message to any controller and transmit it.

●Channel mode messages

<u>Status</u>	<u>2nd byte</u>	<u>3rd byte</u>
BnH	ccH	vvH

n = MIDI channel number: 0H – FH (Ch.1 – 16)
 cc = controller number: 78H – 7FH
 vv = control value: 00H – 7FH

○All sounds off (Controller number 120)

<u>Status</u>	<u>2nd byte</u>	<u>3rd byte</u>
BnH	78H	00H

n = MIDI channel number: 0H – FH (Ch.1 – 16)

* Transmitted in Panic mode.

○Reset all controllers (Controller number 121)

<u>Status</u>	<u>2nd byte</u>	<u>3rd byte</u>
BnH	79H	00H

n = MIDI channel number: 0H – FH (Ch.1 – 16)

* Transmitted in Panic mode.

○All notes off (Controller number 123)

<u>Status</u>	<u>2nd byte</u>	<u>3rd byte</u>
BnH	7BH	00H

n = MIDI channel number: 0H – FH (Ch.1 – 16)

* Transmitted in Panic mode.

■System common message

On the PCR-1 you can assign the following system common messages to any controller and transmit them.

●MTC quarter frame

<u>Status</u>	<u>2nd byte</u>
F1H	mmH

mm = Message type/value

●Song position pointer

<u>Status</u>	<u>2nd byte</u>	<u>3rd byte</u>
F2H	mmH	llH

mm, ll = Song position: 00 00H – 7F 7FH (0-16383)

●Song select

<u>Status</u>	<u>2nd byte</u>
F3H	mmH

mm = Song number: 00 00H – 7F 7FH (0-16383)

●Tune request

<u>Status</u>
F6H

■System realtime message

In addition to the Active Sensing messages that are transmitted constantly, the PCR-1 allows you to assign the following system realtime messages (other than Active Sensing) to any controller and transmit them.

●Timing Clock

<u>Status</u>
F8H

* Transmitted if the System setting F8 CLOCK is ON.

●Start

<u>Status</u>
FAH

●Continue

<u>Status</u>
FBH

●Stop

<u>Status</u>
FCH

●Active sensing

<u>Status</u>
FEH

* Transmitted at intervals of approximately 250 ms.

* Cannot be assigned to a controller.

●System reset

<u>Status</u>
FFH

■ System exclusive message

The PCR-1 is able to transmit the following exclusive messages: exclusive messages assigned to the controllers, Identity Reply, and Bulk Dump.

● Universal non-realtime system exclusive

○ Identity reply

This message will be transmitted when an Identity Request message is received.

Status	Data byte	Status
F0H	7EH,10H,06H,02H,41H,62H,01H, 00H,00H,02H,01H,00H,00H	F7H

Byte	Explanation
F0H	Exclusive status
7EH	ID number (Universal non-realtime message)
10H	Device ID (For the PCR-1, fixed at 10H)
06H	Sub ID #1 (General Information)
02H	Sub ID #1 (Identity Reply)
41H	ID number (Roland)
62H 01H	Device family code
00H 00H	Device family number code
02H 01H	Software revision level
00H 00H	:
F7H	EOX (End of Exclusive)

● Data transmission

○ Data Set 1 DT1 (12H)

Transmitted when you execute Bulk TX in the Bulk mode.

Status	Data byte	Status
F0H	41H, 10H, 00H, 62H, 12H, aaH, ddH, ...eeH, sum	F7H

Byte	Explanation
F0H	Exclusive status
41H	ID number (Roland)
10H	Device ID
00H	Model ID #1 (PCR-1)
62H	Model ID #1 (PCR-1)
12H	Command ID (RQ1)
aaH	Address
ddH	Data
:	
:	
:	
eeH	Data
sum	Checksum
F7H	EOX (End of Exclusive)

- * The amount of data that can be transmitted at once is fixed for each type of data. Data that does not have the specified starting address and data size will not be received. Refer to the explanation in 3. Bulk Dump.
- * There must be an interval of at least 40 ms between each exclusive message that is sent.
- * Also, you must leave an interval of at least 500 ms after transmitting one set of bulk dump data.

3. Bulk dump

Bulk dump allows a large amount of data to be transferred in a single operation. For example, this can be used to store all settings of a device into a computer or sequencer.

On the PCR-1, a bulk dump will be transmitted when you execute the Bulk mode operation BULK TX. The bulk dump is transmitted as several exclusive messages.

Address	Parameter	Packets
00H, 00H, 00H, 00H--00H, 00H, 1A, 7F	Current memory	27

- * You must leave an interval of at least 40 ms between each exclusive message.
- * In the case of ALL BULK, the contents of memories 1--F will be transmitted as the current memory, consecutively from memory 1 through memory F. After transmitting one set of bulk dump data, you must leave an interval of at least 500 ms.
- * Please be aware that if you modify the data dumped from the PCR-1 by changing the order in which the exclusive messages are transmitted, by inserting other messages between the system exclusive messages, or by speeding up the timing of the transmission, the data may not be set correctly when the PCR-1 receives it.

4. Supplementary material

●Decimal and Hexadecimal table

(An "H" is appended to the end of numbers in hexadecimal notation.)

In MIDI documentation, data values and addresses/sizes of Exclusive messages, etc. are expressed as hexadecimal values for each 7 bits.

The following table shows how these correspond to decimal numbers.

Dec.	Hex.	Dec.	Hex.	Dec.	Hex.	Dec.	Hex.
0	00H	32	20H	64	40H	96	60H
1	01H	33	21H	65	41H	97	61H
2	02H	34	22H	66	42H	98	62H
3	03H	35	23H	67	43H	99	63H
4	04H	36	24H	68	44H	100	64H
5	05H	37	25H	69	45H	101	65H
6	06H	38	26H	70	46H	102	66H
7	07H	39	27H	71	47H	103	67H
8	08H	40	28H	72	48H	104	68H
9	09H	41	29H	73	49H	105	69H
10	0AH	42	2AH	74	4AH	106	6AH
11	0BH	43	2BH	75	4BH	107	6BH
12	0CH	44	2CH	76	4CH	108	6CH
13	0DH	45	2DH	77	4DH	109	6DH
14	0EH	46	2EH	78	4EH	110	6EH
15	0FH	47	2FH	79	4FH	111	6FH
16	10H	48	30H	80	50H	112	70H
17	11H	49	31H	81	51H	113	71H
18	12H	50	32H	82	52H	114	72H
19	13H	51	33H	83	53H	115	73H
20	14H	52	34H	84	54H	116	74H
21	15H	53	35H	85	55H	117	75H
22	16H	54	36H	86	56H	118	76H
23	17H	55	37H	87	57H	119	77H
24	18H	56	38H	88	58H	120	78H
25	19H	57	39H	89	59H	121	79H
26	1AH	58	3AH	90	5AH	122	7AH
27	1BH	59	3BH	91	5BH	123	7BH
28	1CH	60	3CH	92	5CH	124	7CH
29	1DH	61	3DH	93	5DH	125	7DH
30	1EH	62	3EH	94	5EH	126	7EH
31	1FH	63	3FH	95	5FH	127	7FH

* The decimal expression of the MIDI channel, program change, etc., is one greater than the decimal value shown in the table above.

* The hexadecimal expression for each 7 bits allows a maximum of 128 steps (0-127) to be expressed by one byte of data. Multiple bytes are used if the data requires greater resolution than this. For example, a value expressed by two 7-bit bytes "aa" and "bbH" would be $aa \times 128 + bb$.

* In the case of signed (+/-) data, 00H = -64, 40H = +/-0, and 7FH = +63; i.e., a value 64 less than the decimal value shown in the above table is used. In the case of a two-byte value, 00 00H = -8192, 40 00 = +/-0, and 7F 7F = +8191. For example, a value of "aa" and "bbH" would have a decimal expression of $aa \text{ bbH} - 40 \text{ 00H} = aa \times 128 + bb - 64 \times 128$.

* In the case of data indicated as "use nibble data," hexadecimal expression in 4-bit units is used. A nibble-expressed value of the two bytes 0a and 0bH would have a value of $a \times 16 + b$.

<Example1>

What is the decimal expression of 5AH?

From the preceding table, 5AH = 90.

<Example2>

What is the decimal expression of the 7-bit hexadecimal value 12 34H?

From the preceding table, 12H = 18, and 34H = 52.

Thus, this is $18 \times 128 + 52 = 2356$

<Example3>

What is the decimal expression of the nibble-expressed value 0A 03 09 0D?

From the preceding table, 0AH = 10, 03H = 3, 09H = 9, and 0DH = 13.

Thus, this is $((10 \times 16 + 3) \times 16 + 9) \times 16 + 13 = 41885$

<Example4> What is the nibble-expressed value of decimal 1258?

$1258 \div 16 = 78$ (quotient) ... 10 (remainder)

$78 \div 16 = 4$ (quotient) ... 14 (remainder)

$4 \div 16 = 0$ (quotient) ... 4 (remainder)

From the preceding table, 0 = 00H, 4 = 04H, 14 = 0EH, 10 = 0HA.

Thus, the nibble-expressed value is 00 04 0E 0AH

●Example of an actual MIDI message

<Example1> CE 04

CnH is the Program Change status. "n" is the MIDI channel number. EH = 14, and 04H = 04. Thus, this is a program change message on MIDI channel 15, for program number 05.

●Checksum calculation

In order to verify that the message was received correctly, Roland exclusive messages (RQ1, DT1) add a checksum following the end of the data (before the F7). The checksum value is determined by the address and data (or size) of the exclusive message that is transmitted.

○Calculating the checksum

("H" has been added following hexadecimal values)

The checksum is a value that results in a lower 7 bits of 0 when the address, size, and checksum itself are added together.

Specifically, the calculation will be as follows when the exclusive message you want to transmit has an address of aa bb cCH and data or size of dd ee fFH.

$$\begin{aligned} aa + bb + cc + dd + ee + ff &= \text{total} \\ \text{total} \div 128 &= \text{quotient} \dots \text{remainder} \\ 128 - \text{remainder} &= \text{checksum} \end{aligned}$$

* However, as an exception, the checksum for a remainder of 0 is not 80H but rather 00H.

USB AUDIO INTERFACE /
MIDI KEYBOARD CONTROLLER
Model PCR-1

Date : Jan. 1, 2004

Version : 1.00

MIDI Implementation Chart

Function...	Transmitted	Recognized	Remarks
Basic Channel Default Changed	1 1—16	X X	
Mode Default Messages Altered	Mode 3 OMNI ON/OFF, MONO, POLY *****	X X X	
Note Number : True Voice	0—127 *****	X X	
Velocity Note On Note Off	O (9n v=1—127) O (9n v=0)	X X	
After Touch Key's Channel's	O O	X X	
Pitch Bend	O	X	
Control Change 0-119	O	X	
Program Change : True Number	O (0—127) *****	X X	
System Exclusive	O	O	
System Common : Song Position : Song Select : Tune Request	O O (0—127) O	X X X	
System Real Time : Clock : Commands	O O	X X	
Aux Messages : All Sound Off : Reset All Controllers : Local On/Off : All Notes Off : Active Sensing : System Reset	O *1 (120) O *1 (121) O O *1 (123) O O	X X X X X X	
Notes	* 1 When PANIC is transmitted.		

Mode 1 : OMNI ON, POLY
Mode 3 : OMNI OFF, POLY

Mode 2 : OMNI ON, MONO
Mode 4 : OMNI OFF, MONO

O : Yes
X : No

Main specifications

■ PCR-1: USB Audio Interface / MIDI Keyboard Controller

● Number of Audio Record/Playback Channels

Record: 1 pair of stereo

Playback: 1 pair of stereo

Full duplex (except for 96 kHz setting)

● Signal Processing

AD/DA Conversion: 24 bits

PC interface: 24 bits

● Sampling Rate

44.1/48/96 kHz

● Nominal Input Level

-10 dBu

● Input Impedance

27 k ohms

● Nominal Output Level

-10 dBu

● Output Impedance

1 k ohms

● Connectors

USB connector: Type B

Line Input jacks (L, R): RCA phono type

Line Output jacks (L, R): RCA phono type

Headphones jack: Stereo miniature phone type

Digital Output connector: Optical type

● Keyboard

25 Keys (with velocity)

● Controllers

Master Volume Knob

Memory Button

MIDI Channel Button

Shift Button

Octave Shift Buttons (+/-)

Transpose Button

Assignable Buttons (B1--6)

Pitch Bend Switch

Modulation Switch

Assignable Rotary Volume Knobs (R1--8)

● Display

7 segments, 3 characters (LED)

● Rear Panel

Input Level Knob

● Power Supply

USB Bus Power

● Current Draw

400 mA

● Dimensions

450(W) x 220(D) x 28(H) mm

17-3/4 (W) x 8-11/16 (D) x 1-1/8 (H) inches

● Weight

1.5 kg / 3 lbs 5 oz

● Accessories

CD-ROM

USB Cable

Owner's Manual

Template Sheets (GM2, BLANK)

(0 dBu = 0.775 V rms)

** In the interest of product improvement, the specifications and/or appearance of this unit are subject to change without prior notice.*

index

A

Active sensing 118
Advanced mode 61, 96
AFTERTOUCHE 61, 65–66
AFTERTOUCHE ASSIGN 61, 65–66
Aftertouch message 65
ALL BULK 89, 91–92
All notes off 58, 118
All sounds off 58, 118
AppleTalk 34, 36, 114
ASIO 38, 40, 44, 97
ASIO Control Panel 39–40
ASIO Device 38
ASIO Direct Monitor 40, 44
ASIO driver 38
ASSIGN COPY 61, 86
Assignments 61
Audio Devices 44
Audio flow 43

B

BANK 50, 55, 57
Bank mode 50, 57
bank select 50, 117
Basic mode 61
Bend Pitch Control 84
BENDER Switch 11
block number 77, 81
Buffer Size 29, 39
BULK 89–91
Bulk dump 89
Bulk mode 90

C

CANCEL 11, 50, 52
Channel mode messages 118
CHANNEL PRESSURE 65, 100, 118
Channel voice messages 117
CHECKSUM 77, 79, 84, 120
Continue 118
CONTROL CHANGE 61, 68–69, 117
CONTROL CHANGE ASSIGN 61, 68–69
Controllers 10
COPY 86
CTRL IN port 45
Cubase 102
current channel 53
current memory 88–89

D

data area 80, 83–84
Data entry 74
DATA OUT 9
Data transmission 117, 119
DEC Button 10
Decimal 10, 54, 120
DECIMAL Button 10
Decimal input mode 10, 54
Deleting the driver 110
device 46
Device Manager 112–113
Digital output jack / Headphone jack 12
Digital Signature 21–22, 109
Direct Monitor 40, 44, 93, 97
DIRECT MONITOR ON / OFF 93, 97
Display 9
driver 44, 46, 95–96
Driver Signing 14, 18, 20, 23
DT1 117, 119

E

EDIROL PCR-1 26–28, 44
 EDIT 50, 61
 EDIT Button 9
 Edit mode 50, 61
 Error 90
 Error display 90

F

F8 CLOCK 93
 F8 CLOCK DEFAULT TEMPO 93–94
 F8 CLOCK ON / OFF 93–94
 F8 CLOCK PORT SET 93–94
 FACTORY RESET 93, 95
 FPT 95
 FreeMIDI 36

G

Generic driver 95
 GM2 MEMORY 95
 GM2 set 100
 GM2 System On 82
 GS SET 103–104

H

H-ACTIVITY ON / OFF 93, 95
 H-COMPATIBLE SET 103
 HEX 9, 54
 HEX Button 10
 Hexadecimal 10, 54, 120
 Hexadecimal input mode 10, 54

I

Identity reply 119
 Identity request message 117
 INC Button 10
 Input jacks 12
 input mode 54
 Input volume 12
 Insert Disk 16–17

K

KEYBOARD PORT SET 93–94

L

LAST ACCESS MEMORY 95
 Latch mode 62
 Latency 29, 39
 LSB 50, 57, 72, 74, 76, 80, 83

M

Master output jacks 12
 Master volume knob 9
 MCR-8 MODE SET 101–102
 MEMORY 50, 59
 MEMORY / PGM CHANGE Button 9
 Memory mode 50, 59
 memory number 59
 Memory sets 59
 MIDI 50
 MIDI CH 50, 53
 MIDI CH / BANK SEL Button 9
 MIDI Channel mode 50, 53
 MIDI Devices 44
 MIDI flow 43
 MME EDIROL PCR-1 In 44
 MME EDIROL PCR-1 Out 44
 Modulation 52, 117
 MODULATION Button 11
 MODULATION SETTING 93, 97
 MSB 50, 57, 72, 74, 76, 80, 83
 MTC quarter frame 118
 Multimedia Properties 28

N

NO ASSIGN 61, 87
 NOTE 61
 NOTE ASSIGN 61, 63
 Note message 63
 Note off 117
 Note on 117
 NRPN 61, 74
 NRPN ASSIGN 61

O

OCTAVE	11, 52
OCTAVE - / +	11
Octave Shift	52
OMNI	54
OMNI OFF	54
OMNI ON	54
OMS	34
Optical	12
Original driver	95
Other device	107

P

PANIC	50, 58
Panic mode	50, 58
PC DEC	71, 73
PC INC	71, 73
PCR-1	44
PCR-1 1	44
PCR-1 2	44
pitch	11, 52
Pitch Bend	52
Pitch bend change	118
PITCH BEND TIME	93, 97
PLAY mode	50–51
Polyphonic Key Pressure	65–66, 117
port	43–45, 62
Power Management	113
Preferred device	27–28
Program	118
PROGRAM CHANGE	50, 54, 56, 61, 118
PROGRAM CHANGE ASSIGN	61, 71
Program Change Decrement function	73
Program Change Increment function	73
Program Change mode	50, 56
PROTECT	92
PROTECT OFF	92
PROTECT ON	92

R

Receive data	117
Reset all controllers	58, 118
rotary encoder	68
RPN	61, 74
RPN / NRPN ASSIGN	61, 74
RPN ASSIGN	61

S

sampling frequency	32, 46–47, 49, 93, 96
SAVE	88, 92
Security Slot	12
SHIFT Button	9
SINGLE BULK	89
SNAPSHOT	50, 60
Snapshot mode	50, 60
SONAR	101
Song position pointer	118
Song select	118
Sounds and Audio Devices	26–27
Standard driver mode	96
Start	118
STARTUP MEMORY	93, 95
Stop	118
Sys Ex.	61
Sys Ex. ASSIGN	61, 77, 80
Sys Ex. message	77
SYSTEM	93
System common message	118
system exclusive message	77, 80–82, 117, 119
system message	77
System realtime message	118
System reset	118

T

Template sheets	6
TEMPO	61, 85
TEMPO ASSIGN	61
Timing Clock	118
Toggle mode	62
Transmit data	117
TRANSPOSE	52
TRANSPOSE / ENTER Button	11
Tune request	118

U

Universal non-realtime system exclusive	119
Universal non-realtime system exclusive message	117
Unknown device	107
USB	9
USB AUDIO MODE SETTING	93, 96
USB AUDIO ON / OFF	93, 96
USB cable	6
USB connector	12
USB MIDI DRIVER MODE	93, 95

V

VELOCITY OFFSET	93–94
vibrato	52

X

XG SET	105
--------------	-----



For EU Countries

This product complies with the requirements of European Directive 89/336/EEC.

For Canada

This Class B digital apparatus meets all requirements of the Canadian Interference-Causing Equipment Regulations.

For the USA

DECLARATION OF CONFORMITY Compliance Information Statement

Model Name : PCR-1
Type of Equipment : USB AUDIO INTERFACE/MIDI KEYBOARD CONTROLLER
Responsible Party : Edirol Corporation North America
Address : 425 Sequoia Drive, Suite 114, Bellingham, WA 98226
Telephone : (360) 594-4276

